

PROFILE

VON SWS GLASSYSTEME





>> GESTALTUNG MIT PROFILEN

Ob Abtrennung, Raumteilung oder Glasduschwand – mit unseren Profilen lassen sich ganz unterschiedliche Konstruktionen erstellen. Für ein edles Erscheinungsbild sorgen die verschiedenen lieferbaren Oberflächen.

GESTALTUNG MIT PROFILEN

PROFILE VON SWS GLASSYSTEME



INHALT







EINZELTEILE

U-Profile	05
Winkelprofile	10
Spiegelprofil	12
Verglasungsprofile / Klemmprofile	14







Oberflächen



Material: Aluminium

						
E0	E0/14	E1/22	E1/23	E3/50	E6EV1	E6EV5
roh	weiß	Edelstahl- Optik	Alinox	verchromt	naturfarbig	Glanzeloxal

Material: Kunststoff

			
KU1	KU6	KU7	KU22
weiß	matt- verchromt	glanz- verchromt	Edelstahl- Optik

Material: Edelstahl

	
VA1	VA2
poliert	matt gebürstet

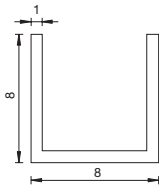

U-Profil



Material: Aluminium
 Größe: 8 x 8 x 5000 x 1 mm
 Plattendicke: ≤ 6 mm – WICHTIG: + Toleranz nicht möglich

Art.-Nr.	Oberfläche
5000E6EV1-5M	naturfarbig

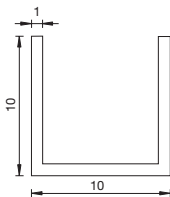
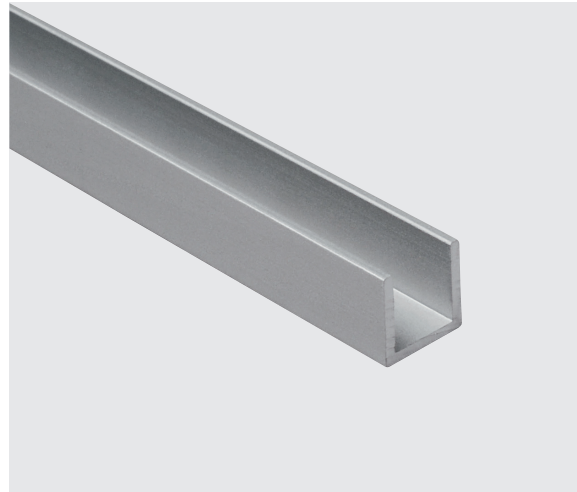

U-Profil



Material: Aluminium
 Größe: 10 x 10 x 5000 x 1 mm
 Plattendicke: ≤ 8 mm – WICHTIG: + Toleranz nicht möglich

Art.-Nr.	Oberfläche
5010E1/23-5M	Alinox
5010E6EV1-5M	naturfarbig

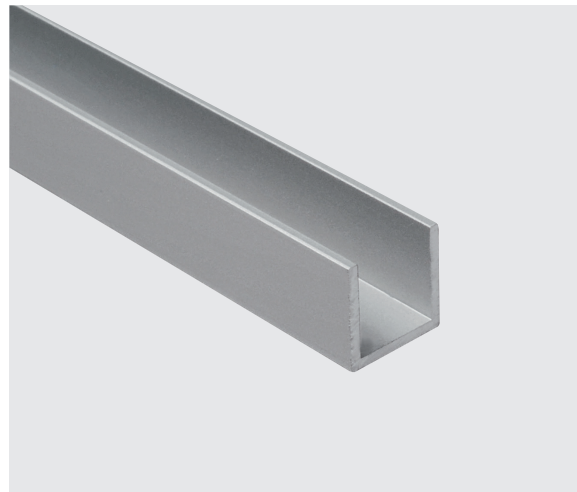

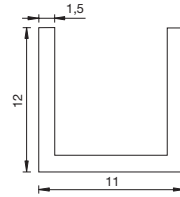
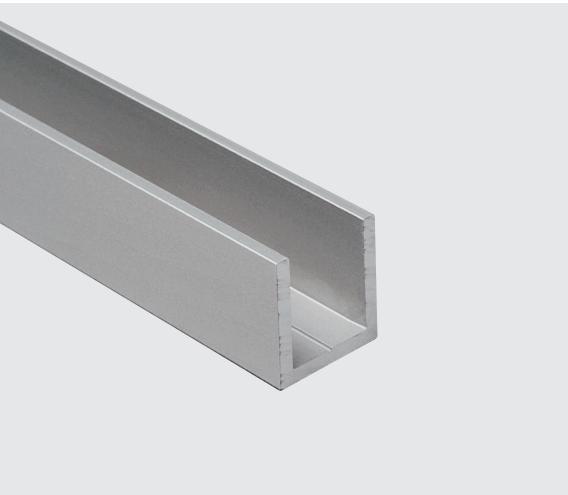

U-Profil

Material: Aluminium

Größe: 12 x 11 x 5000 x 1,5 mm

Plattendicke: ≤ 8 mm – WICHTIG: + Toleranz nicht möglich

Art.-Nr.	Oberfläche
5012E1/23-5M	Alinox
5012E6EV1-5M	naturfarbig

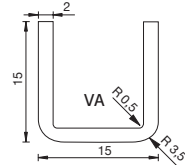
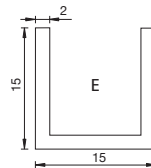
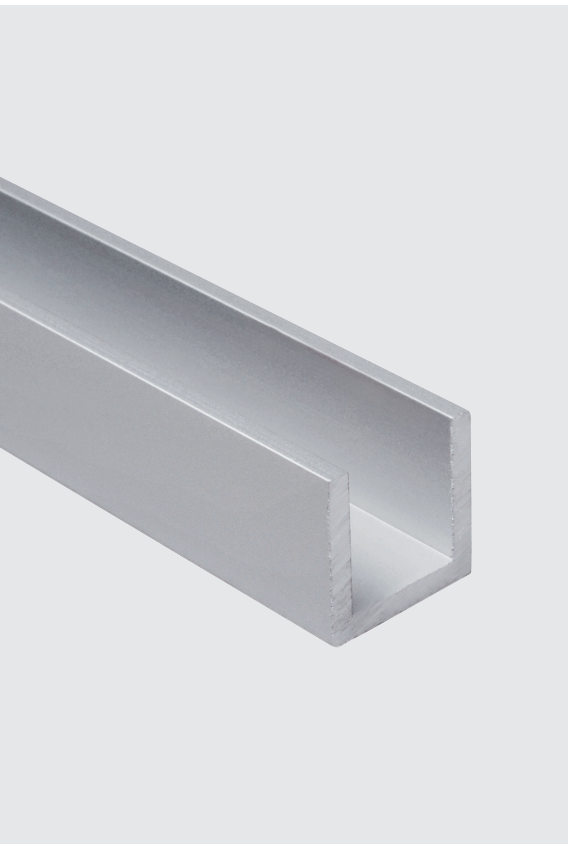

U-Profil

Material: Aluminium/Edelstahl

Größe: 15 x 15 x 5000 x 2 mm

Plattendicke: ≤ 11 mm

Art.-Nr.	Oberfläche	Material
5015E0-5M	roh	Aluminium
5015E0/14-5M	weiß	Aluminium
5015E1/22-5M	Edelstahl-Optik	Aluminium
5015E1/23-5M	Alinox	Aluminium
5015E3/50-5M	verchromt	Aluminium
5015E6EV1-5M	naturfarbig	Aluminium
5015E6EV5-5M	Glanzeloxal	Aluminium
5015VA1-5M*	poliert	Edelstahl
5015VA2-5M*	geschliffen	Edelstahl

*Auch in 2500 mm Länge erhältlich

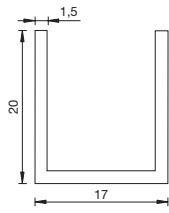

U-Profil

Material: Aluminium
 Größe: 20 x 17 x 5000 x 1,5 mm
 Plattendicke: ≤ 14 mm

Art.-Nr.	Oberfläche
5017E0-5M	roh
5017E0/14-5M	weiß
5017E1/22-5M	Edelstahl-Optik
5017E1/23-5M	Alinox
5017E3/50-5M	verchromt
5017E6EV1-5M	naturfarbig
5017E6EV5-5M	glanzeloxiert

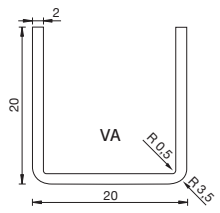
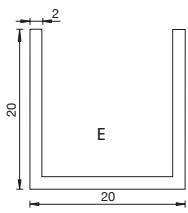
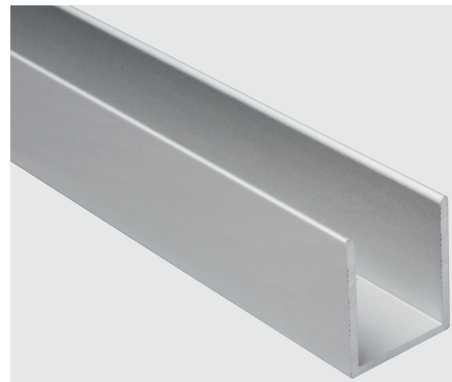

U-Profil

Material: Aluminium/Edelstahl
 Größe: 20 x 20 x 5000 x 2 mm
 Plattendicke: ≤ 16 mm

Art.-Nr.	Oberfläche	Material
5020E0/14-5M	weiß	Aluminium
5020E1/22-5M	Edelstahl-Optik	Aluminium
5020E1/23-5M	Alinox	Aluminium
5020E3/50-5M	verchromt	Aluminium
5020E6EV1-5M	naturfarbig	Aluminium
5020VA1-5M*	poliert	Edelstahl
5020VA2-5M*	geschliffen	Edelstahl



*Auch in 2500 mm Länge erhältlich

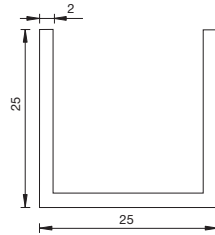
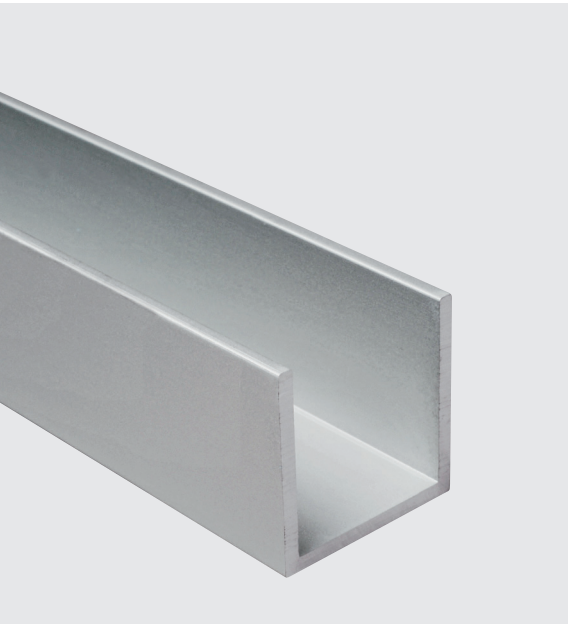

U-Profil



Material: Aluminium
 Größe: 25 x 25 x 5000 x 2 mm
 Plattendicke: ≤ 21 mm

Art.-Nr.	Oberfläche
5025E1/22-5M	Edelstahl-Optik
5025E1/23-5M	Alinox
5025E6EV1-5M	naturfarbig

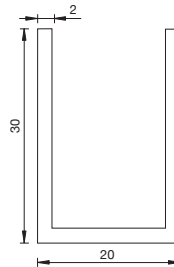

U-Profil



Material: Aluminium
 Größe: 30 x 20 x 5000 x 2 mm
 Plattendicke: ≤ 16 mm

Art.-Nr.	Oberfläche
5030E0/14-5M	weiß
5030E1/22-5M	Edelstahl-Optik
5030E1/23-5M	Alinox
5030E3/50-5M	verchromt
5030E6EV1-5M	naturfarbig

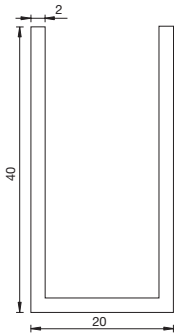
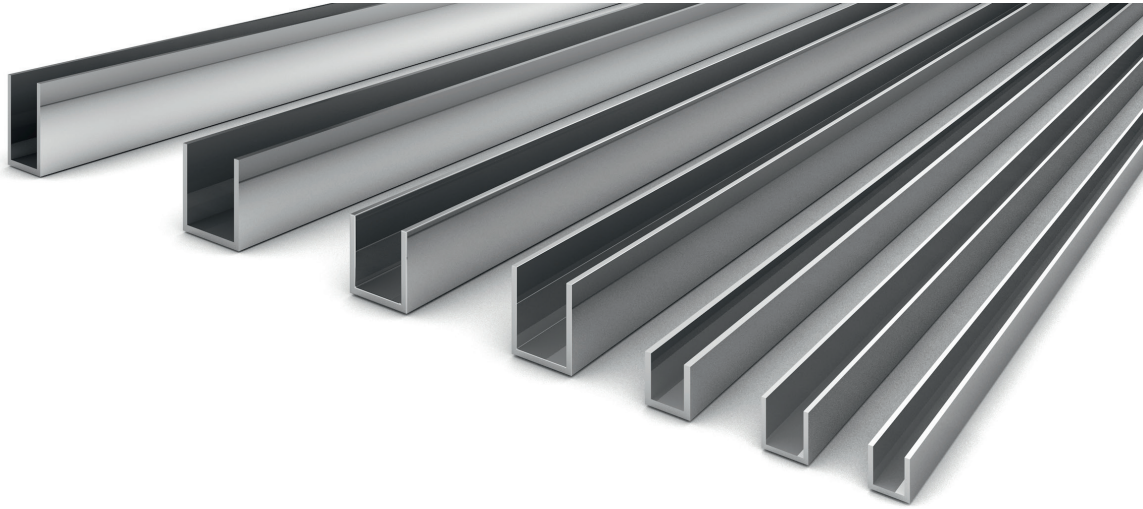

U-Profil



Material: Aluminium
 Größe: 40 x 20 x 5000 x 2 mm
 Plattendicke: ≤ 16 mm

Art.-Nr.	Oberfläche
5040E0/14-5M	weiß
5040E1/22-5M	Edelstahl-Optik
5040E1/23-5M	Alinox
5040E6EV1-5M	naturfarbig

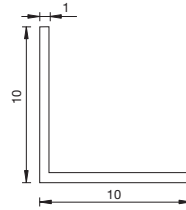
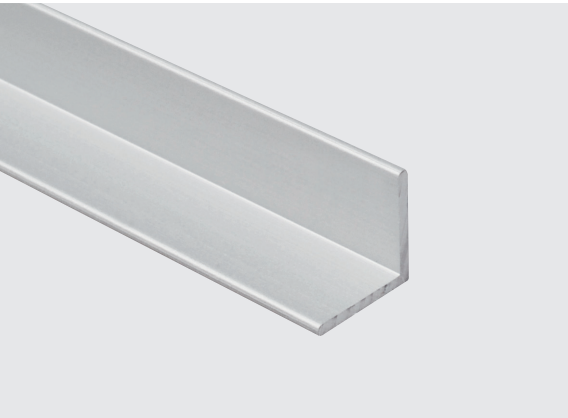

Winkelprofil



Material: Aluminium
Größe: 10 x 10 x 5000 x 1 mm

Art.-Nr.	Oberfläche
5110E1/22-5M	Edelstahl-Optik
5110E6EV1-5M	naturfarbig

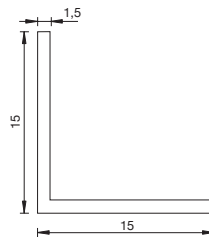

Winkelprofil



Material: Aluminium
Größe: 15 x 15 x 5000 x 1,5 mm

Art.-Nr.	Oberfläche
5115E1/22-5M	Edelstahl-Optik
5115E1/23-5M	Alinox
5115E6EV1-5M	naturfarbig

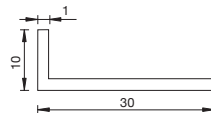
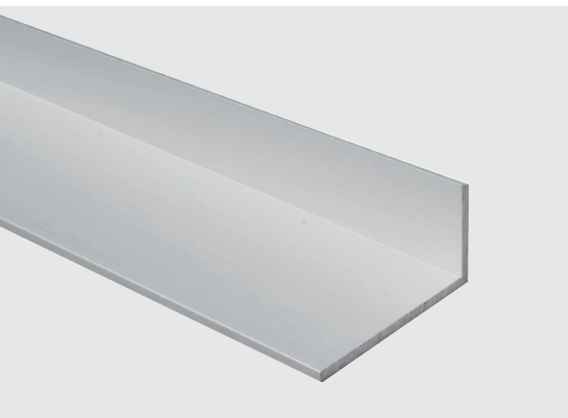

Winkelprofil



Material: Aluminium
Größe: 30 x 10 x 5000 x 1 mm

Art.-Nr.	Oberfläche
5130E1/23-5M	Alinox

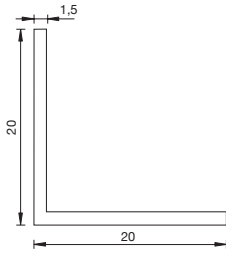

Winkelprofil

Material: Aluminium

Größe: 20 x 20 x 5000 x 1,5 mm

Art.-Nr.	Oberfläche
5120E0-5M	roh
5120E1/22-5M	Edelstahl-Optik
5120E1/23-5M	Alinox
5120E6EV1-5M	naturfarbig

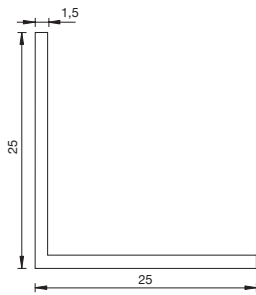

Winkelprofil

Material: Aluminium

Größe: 25 x 25 x 5000 x 1,5 mm

Art.-Nr.	Oberfläche
5125E1/22-5M	Edelstahl-Optik
5125E6EV1-5M	naturfarbig

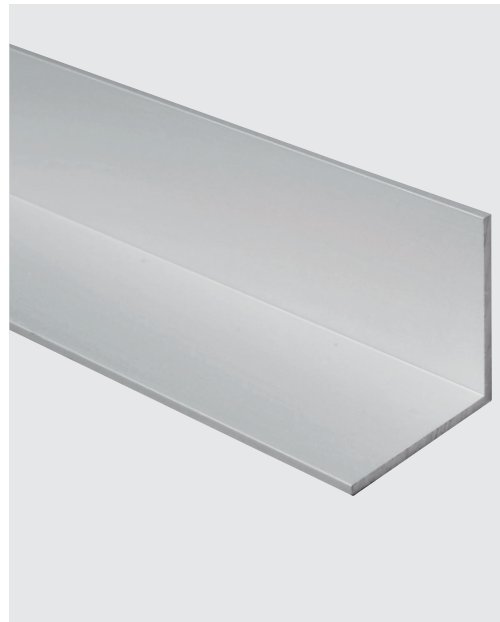



Anwendung Spiegelprofil

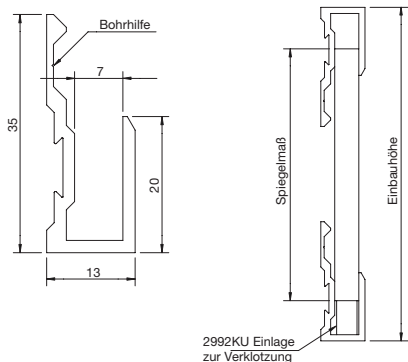

Spiegelprofil



Material: Aluminium
 Größe = Einbauhöhe – 24 mm
 Plattendicke: < 7 mm

Art.-Nr.	Oberfläche
2990E0/14-5M	weiß
2990E1/22-5M	Edelstahloptik
2990E6EV1-5M	naturfarbig

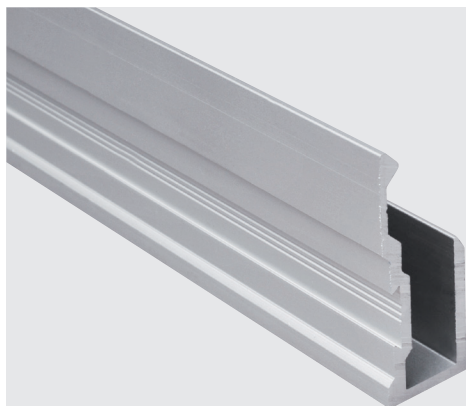

Endstück



Material: Kunststoff
 Endstück zur Steckmontage
 rechte (-R) und linke (-L) Ausführung

Art.-Nr.	Oberfläche
2991KU1-L	weiß
2991KU1-R	weiß
2991KU6-L	mattverchromt
2991KU6-R	mattverchromt

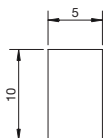

Einlage zur Verklotzung



Material: Kunststoff

Art.-Nr.	Oberfläche
2992KU	Kunststoff

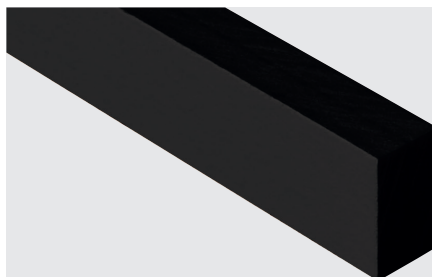

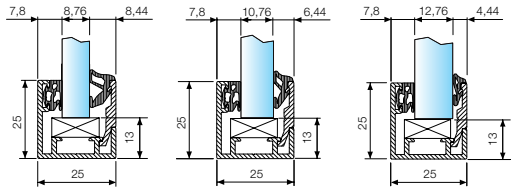

Verglasungsprofil



Material: Aluminium
 Größe: 25 x 25 x 6000 mm
 Oberfläche: naturfarbig

Art.-Nr.	Glasstärke
75030238	8/8,76
75031238	10/10,76
75032238	12/12,76

Blende und Dichtungen im Set enthalten

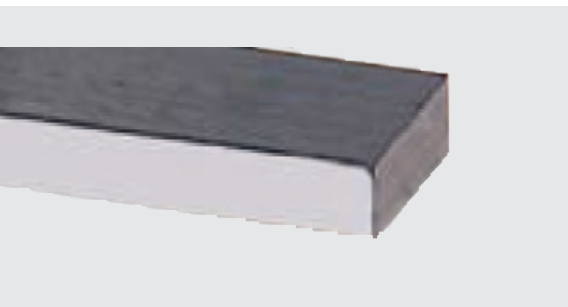

Einlage zur Verklotzung



Material: Kunststoff
 Profillänge: 2800 mm

Art.-Nr.	Oberfläche
75036600	roh

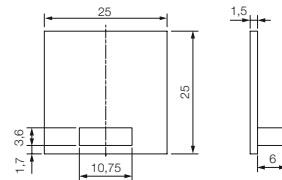

Abschlusskappe



Material: Kunststoff

Art.-Nr.	Oberfläche
75037631	schwarz





Klemmprofil

Material: Aluminium
 Länge: 2010 mm (5 Klemmbacken) | 2500 mm (6 Klemmbacken)
 Plattendicke = 8 mm

Art.-Nr.	Länge	Oberfläche
8884E6EV5-2010-8	2010 mm	Glanzeloxal
8884E6EV5-2500-8	2500 mm	Glanzeloxal

Endkappen sind nicht im Set enthalten.



Klemmprofil

Material: Aluminium
 Länge: 2010 mm (5 Klemmbacken) | 2500 mm (6 Klemmbacken)
 Plattendicke = 6 / 8 / 10 mm

Art.-Nr.	Länge	Oberfläche
8884E1/23-2010	2010 mm	Alinox
8884E1/23-2500	2500 mm	Alinox
8884E6EV1-2010	2010 mm	naturfarbig
8884E6EV1-2500	2500 mm	naturfarbig
8884E6EV5-2010	2010 mm	Glanzeloxal
8884E6EV5-2500	2500 mm	Glanzeloxal



Klemmprofil

Material: Aluminium
 Länge: -5000 mm (12 Klemmbacken)
 Plattendicke = 6 / 8 / 10 mm

Art.-Nr.	Länge	Oberfläche
8884E6EV1-5000	5000 mm	naturfarbig

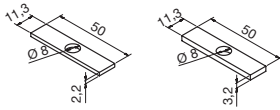

Zwischenlage

Material: Hartzell

Art.-Nr.	Oberfläche
8885HZ	Hartzell

8885 Zwischenlage zum Ausgleich von Unebenheiten in der Wand: Durch Kombination und/oder Verdopplung können Unebenheiten ab 2 mm in 1 mm-Schritten ausgeglichen werden.

Endkappen geschlossen



Material: Kunststoff
Plattendicke = 6 / 8 / 10 mm

Art.-Nr.		Oberfläche
8884-8KU6-6	6 mm	mattverchromt
8884-8KU6-8	8 mm	mattverchromt
8884-8KU6-10	10 mm	mattverchromt
8884-8KU22-6	6 mm	Edelstahloptik
8884-8KU22-8	8 mm	Edelstahloptik
8884-8KU22-10	10 mm	Edelstahloptik

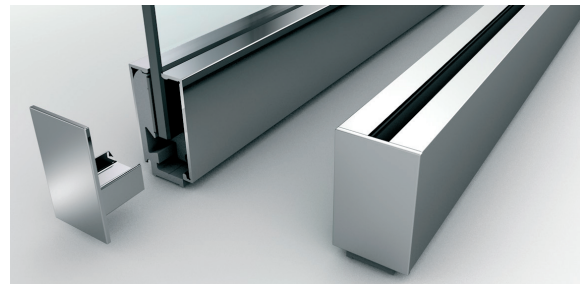
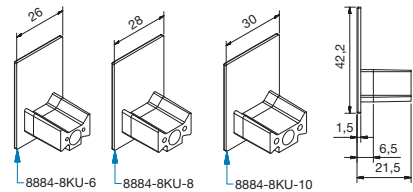

Endkappen ausgeklint



Material: Kunststoff
Plattendicke = 6 / 8 / 10 mm

Art.-Nr.		Oberfläche
8884-9KU6-6	6 mm	mattverchromt
8884-9KU6-8	8 mm	mattverchromt
8884-9KU6-10	10 mm	mattverchromt
8884-9KU22-6	6 mm	Edelstahloptik
8884-9KU22-8	8 mm	Edelstahloptik
8884-9KU22-10	10 mm	Edelstahloptik

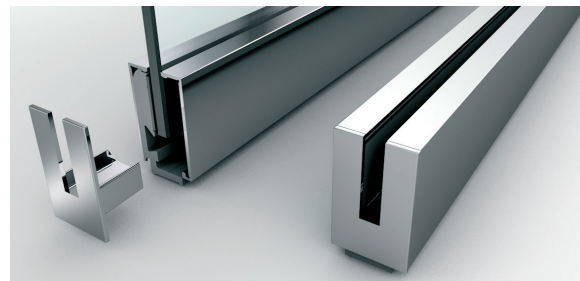
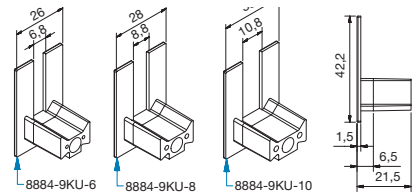

KLEMMPROFIL – Anwendung für vertikale Befestigung

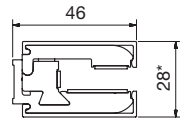
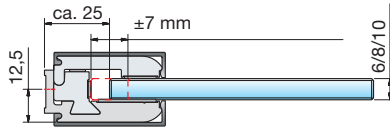

*bei 8 mm Glas

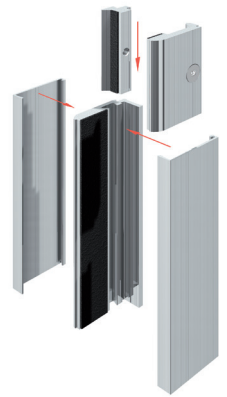

KLEMMPROFIL – Anwendung für Oberlicht

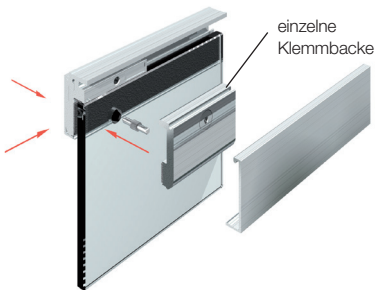
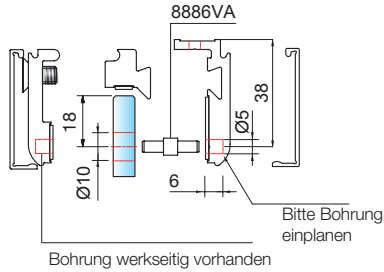
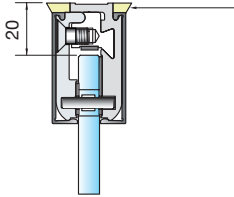

Zubehör: Sicherungsstift

für Verwendung als Deckenabhängung pro Klemmbacke ein Sicherungsstift

Art.-Nr.
8886VA

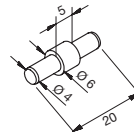

Glasbearbeitung

mit Entlastungsschnitt

