

PRIMUS

GLASSCHIEBETÜRBESCHLÄGE

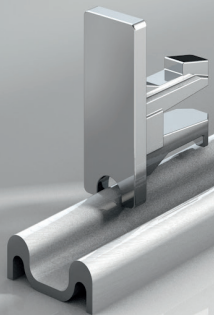

GLASSYSTEME



ästhetisch – robust – langlebig

GLASSCHIEBETÜRBESCHLÄGE VON SWS GLASSYSTEME

>> MODELL 2100

Mit unseren Systemen realisieren Sie Schaukästen und Vitrinen. Die Technik ist bewährt und alle Komponenten sind robust und langlebig.





INHALT

SCHIEBETÜRBESCHLÄGE

Modell 2100 (5-8 mm Glasstärke) S.06

ZUBEHÖR

Anwendungs- & Montagezubehör S.17



Oberflächen

Material: Zink



ZN1

matt-
verchromt

Material: Aluminium



E3/1

matt-
verchromt



E3/5

glanz-
verchromt



E6/EV1

Alu-Optik

Material: Stahl



ST8

verzinkt

Material: Kunststoff



KU0

transparent



KU6

matt-
verchromt

SCHIEBETÜR BESCHLAG MODELL 2100 für Plattendicke 5-8 mm

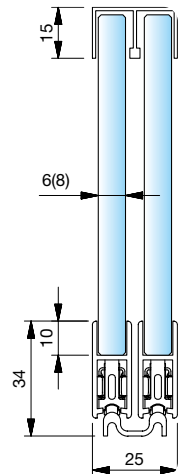
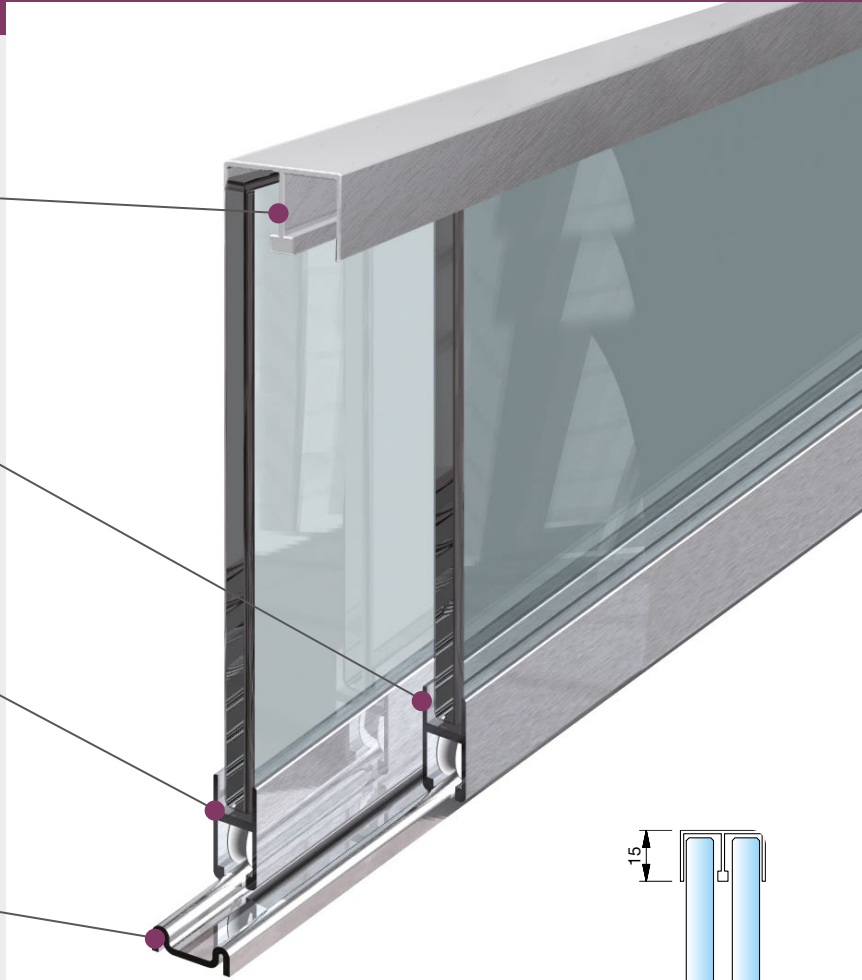
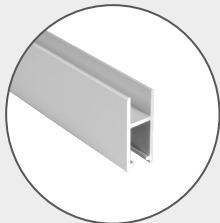
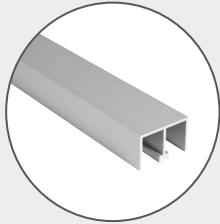

TECHNISCHE ANGABEN

Maximale Belastung pro Flügel

2 x 2103 ST8 = ca. 25 kg

4 x 2103 ST8 = ca. 50 kg

Berechnung des Glasmaßes ohne Klemmprofil:

Einbauhöhe - 31 mm = Glasmaß

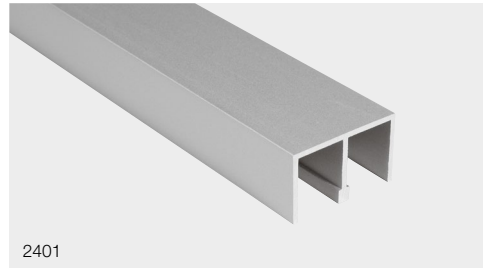
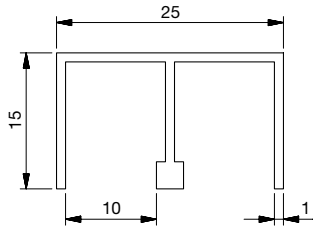

2401

Obere Doppel-U-Führungsschiene



ungebohrt

Material: Aluminium, naturfarbig

Art.-Nr.	 5-8 mm	Ausführung
2401E6EV1-5M	5-8 mm	

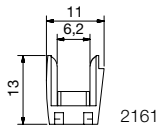

2161

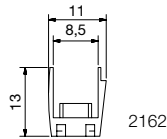

2162

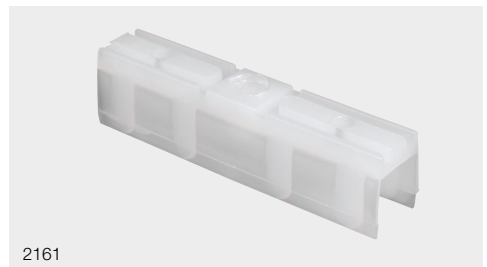
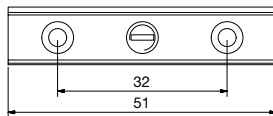
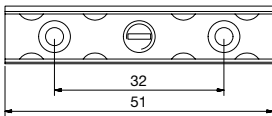

2161

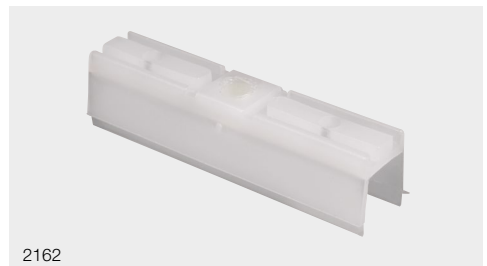

2162

Aushängesicherung/Klapperschutz



Material: Kunststoff

Art.-Nr.	 6 mm	Oberfläche
2161KU0	6 mm	transparent
2162KU0	8 mm	transparent



2756



2758

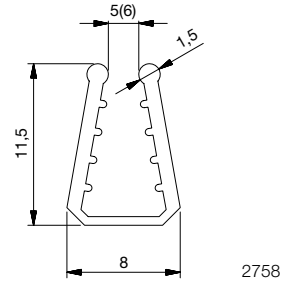
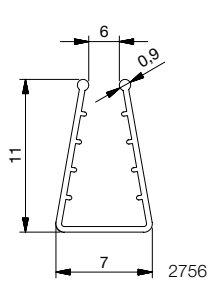

Klemmpprofil (25m Rolle)



Material: Kunststoff

Art.-Nr.		für Laus Schuh	Oberfläche
2756KU0	6 mm	2122	transparent
2758KU0	5 mm	2122	transparent
2758KU0	6 mm	2124	transparent



2122



2124

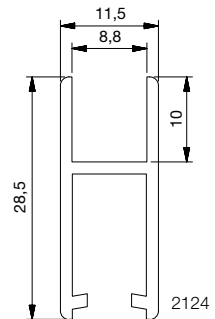
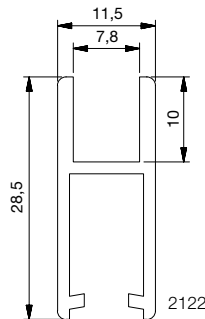

Laufschuh



mit Schutzfolie
Material: Aluminium

Art.-Nr.		Oberfläche
2122E6EV1-5M	5-6 mm	naturfarbig
2124E6EV1-5M	6-8 mm	naturfarbig

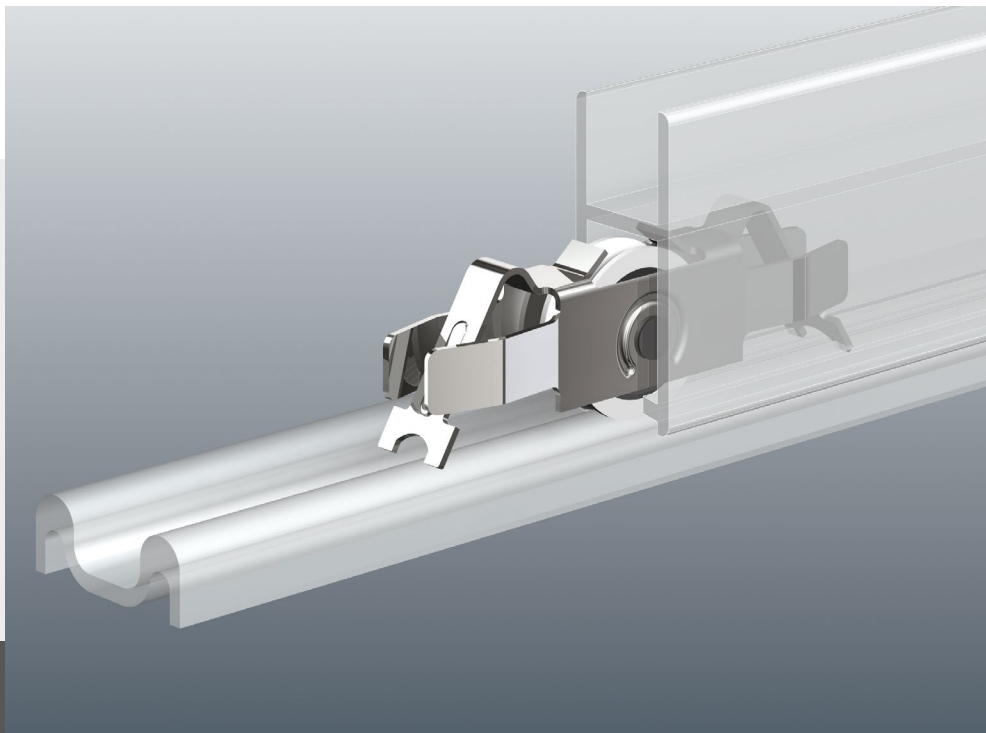

Rolleneinsatz

mit kunststoffummantelter Stahlkugellagerrolle
 Material: Stahl

Art.-Nr.	Oberfläche
2103ST8	verzinkt

Zubehör 2145 auf S. 10



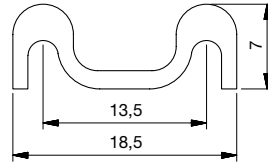

Untere Doppelaufschiene

mit doppelseitigem Klebeband

Art.-Nr.	Oberfläche
2007E6EV1-5M	naturfarbig

Zubehör 5015, 5016 auf S. 26



Montagewerkzeug

aus Makrolon für Rolleneinsatz 2103
Material: Kunststoff

Art.-Nr.	Oberfläche
2145KU0	transparent



Anleitung

1. Rolleneinsatz auf das Montagewerkzeug aufstecken und in den Laufschiene einschieben
2. Montagewerkzeug abziehen

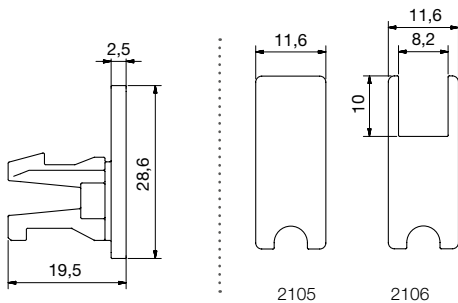

Endstück 

Material: Kunststoff

Art.-Nr.	Oberfläche	Ausführung
2105KU6	mattverchromt	geschlossen
2106KU6	mattverchromt	ausgeklinkt



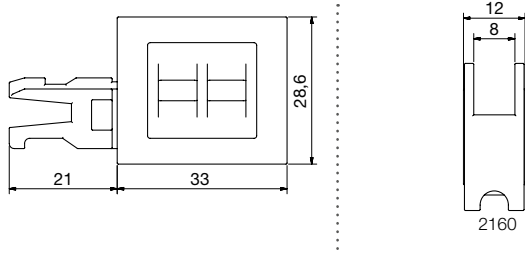

2160

Lauschuhgriff



Material: Kunststoff
 Plattendicke: 5-8 mm

Art.-Nr.	Oberfläche	Ausführung
2160KU6	mattverchromt	ausgeklint

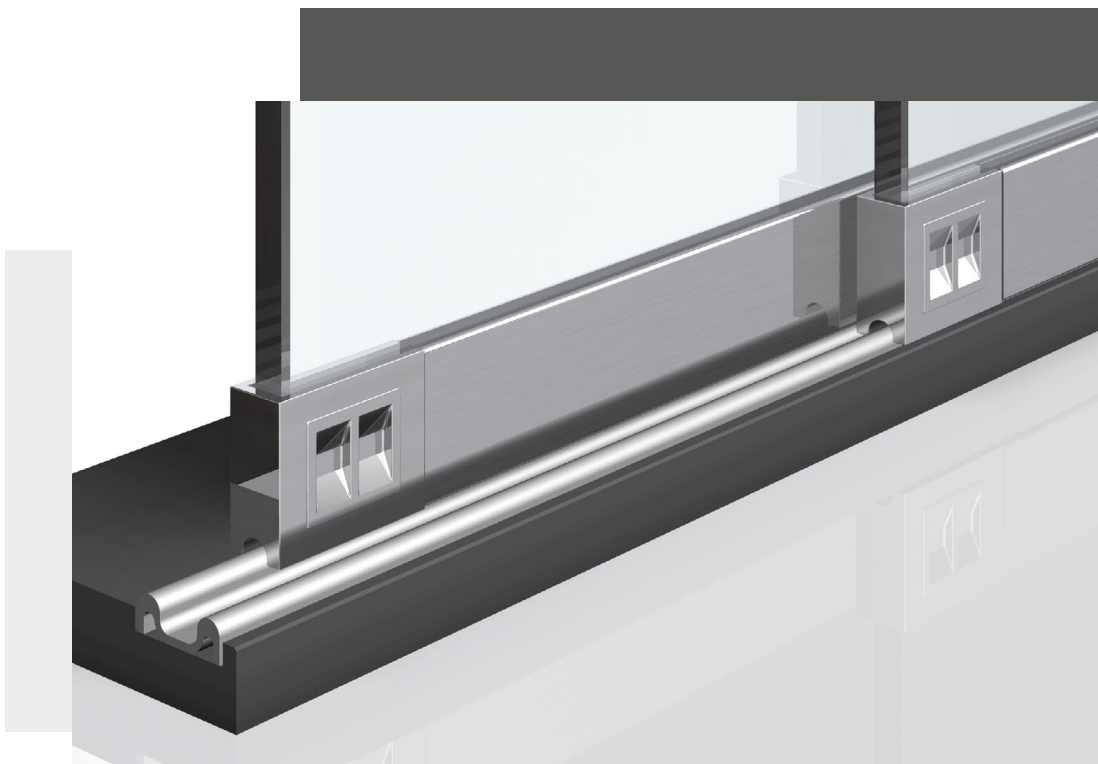

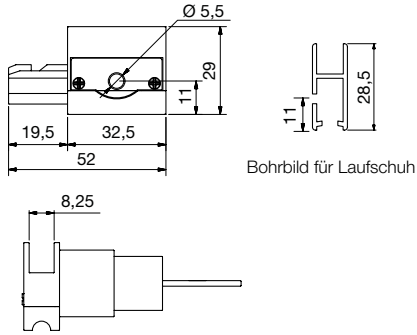

Laufschuhschloss

rechts und links verwendbar, mit zwei Schlüsseln, ausgeklinkt
Material: Zink

Art.-Nr.	Oberfläche	Ausführung
2116ZN1-G	mattverchromt	gleichschließend
2116ZN1-V	mattverchromt	verschiedenschließend



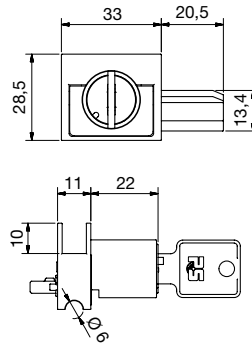
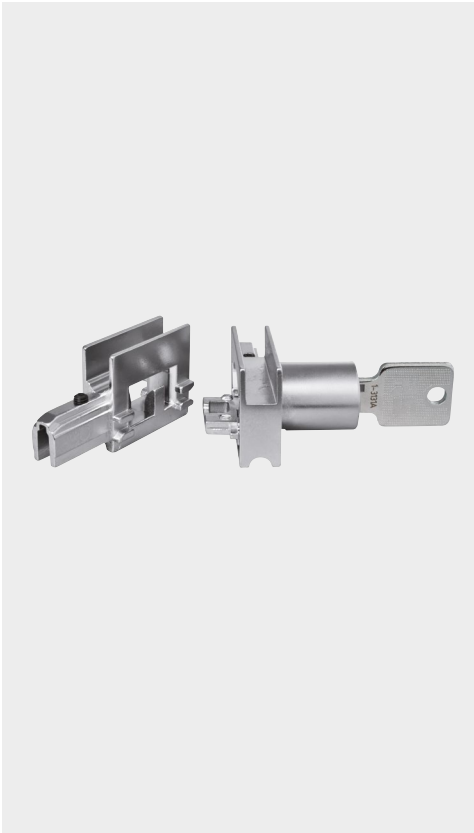

Sicherheits-Laufschuhschloss

rechts und links verwendbar , mit Schlüssel, ausgeklinkt
 Material: Zink

Art.-Nr.	Oberfläche	Ausführung
2126ZN1-G	mattverchromt	gleichschließend



Demontagestift

für Art.-Nr. 2126
 Material: Stahl

Art.-Nr.	Oberfläche
2127ST8	verzinkt



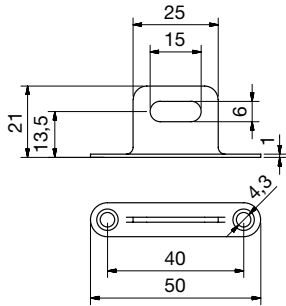

Aushängesicherung

Diebstahlsicherung
Material: Zink

Art.-Nr.	Oberfläche
2962ZN1	mattverchromt

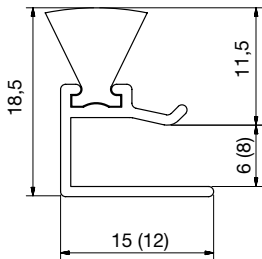

Staubschutzleiste

mit grauen Haarborsten
Material: Aluminium

Art.-Nr.		Oberfläche
2964E6EV1-5M	6 mm	naturfarbig
2965E6EV1-5M	8 mm	naturfarbig







ZUBEHÖR



2944

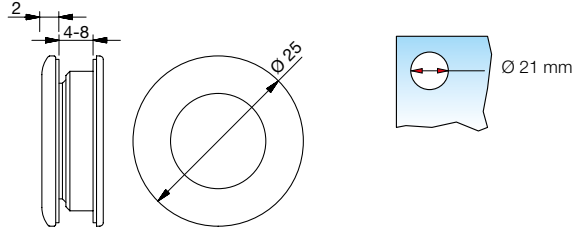

2950

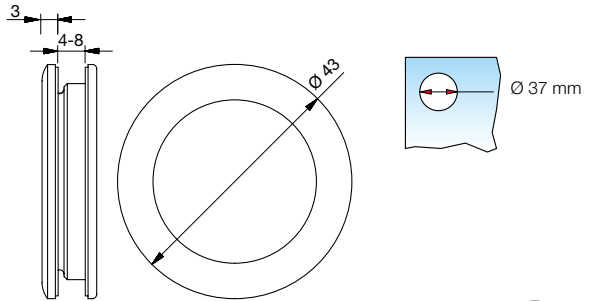

Muschelgriff

zum Schrauben

Material: Aluminium

Art.-Nr.		∅	Oberfläche
2944E3/1	4-8 mm	25 mm	mattverchromt
2944E3/5	4-8 mm	25 mm	glanzverchromt
2950E3/1	4-8 mm	43 mm	mattverchromt
2950E3/5	4-8 mm	43 mm	glanzverchromt



Filzstreifen (10m Rolle)

selbstklebend

Anwendung: als Klapperschutz (bei unbeflockten Führungsschienen) oder als Anschlagdämpfung

Art.-Nr.	Maße
2972	13 mm x 1,5 mm

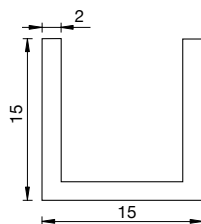

obere Einbahn-Führungsschiene



U-Profil

Material: Aluminium

Maße: 15 x 15 x 5000 x 2 mm

Plattendicke ≤ 11 mm

Art.-Nr.	Ausführung	Oberfläche
5015E6EV1-5M		naturfarbig
5016E6EV1-5M	samtiert, ruhig laufend	naturfarbig