

SWS

GLASSYSTEME

Ganzglasduschen

INTELLIGENTE LÖSUNGEN FÜR DEN DUSCHBEREICH





Alle Bilder, technischen Zeichnungen und deren Beschreibungen sind urheberrechtlich geschütztes Eigentum der SWS Glassysteme GmbH. Technische Maßangaben innerhalb des Kataloges sind unverbindlich. Konstruktionsänderungen sind vorbehalten. Bitte beachten Sie unsere Schutzrechte. Für Druckfehler und Irrtümer, die bei der Herstellung unterlaufen sind, ist jede Haftung ausgeschlossen.

Inhaltsverzeichnis

DUSCHBESCHLÄGE

- Pendeltürband **STORM** Seite 06 – 08
- Winkelverbinder **STORM** Seite 10 – 11
- Pendeltürband **AMBER** Seite 12 – 17
- Winkelverbinder **AMBER** Seite 18 – 21
- Anschlagtürband **TERO** Seite 22 – 27
- Winkelverbinder **TERO** Seite 28 – 29
- Pendeltürband **SUNO** Seite 30 – 35
- Winkelverbinder **TERO** Seite 36 – 37
- Pendeltürband **LUNO** Seite 38 – 44
- Winkelverbinder **LUNO** Seite 45 – 47





ZUBEHÖR

- Griffe..... Seite 48 – 50
- Handtuchhalter..... Seite 51
- Stabilisationsstangen Seite 52 – 59
- Dichtprofile Seite 60 – 66
- Wandanschlußprofil..... Seite 68 – 69
- Profile Seite 70 – 73
- Klemmprofile Seite 74 – 75
- Walk-In Profile Seite 76 – 83



DUSCHTÜRBÄNDER IM VERGLEICH



	 STORM S. 6-11	 AMBER S. 12-21	 TERO S. 22-29	 SUNO S. 30-37	 LUNO S. 38-47
Basismaterial	Messing	Messing	Messing	Messing	Messing
Tragkraft von zwei Bändern	42 kg	42 kg	40 kg	30 kg	50 kg
Maximale Türbreite (bei einer Türhöhe von 2000 mm bei 8 mm Glas)	1000 mm	1000 mm	1000 mm	750 mm	1000 mm
Pendeltür	✓	✓		✓	✓
Anschlagtür			✓		
Durchgehende Dichtung im Bandbereich			✓		
Ohne Dichtungen montierbar	✓	✓		✓	✓
Einstellbare Nulllage	✓	✓		✓	
Auf den letzten Zentimetern selbstschließend	✓	✓		✓	✓
Verdeckte Wandbefestigung	✓	✓	✓		
Verdeckte Verschraubung	✓	✓	✓	✓	
Wandbefestigung mit Langlöchern	✓	✓	✓		

MÖGLICHE EINBAUSITUATIONEN



GLASSYSTEME



Nische 01



Nische 02



Nische 03



Nische 04



Nische 05



Nische 06

STORM	✓	✓	✓	✓	✓	✓
AMBER	✓	✓	✓	✓	✓	✓
TERO	✓	✓	✓	✓	✓	✓
SUNO	✓	✓	✓	✓	✓	✓
LUNO	✓	✓	✓	✓	✓	✓



Eck 01



Eck 02



Eck 03



Eck 04



Eck 05



Eck 06

STORM	✓	✓	✓	✓	✓	✓
AMBER	✓	✓	✓	✓	✓	✓
TERO	✓	✓	✓	✓	✓	✓
SUNO	✓	✓	✓	✓	✓	✓
LUNO	✓	✓	✓	✓	✓	✓



5-Eck 01



U 01



U 02



U 03



Wanne 01



Wanne 02

STORM	✓	✓	✓	✓	✓	✓
AMBER		✓	✓	✓	✓	✓
TERO		✓	✓	✓	✓	✓
SUNO		✓	✓	✓	✓	✓
LUNO	✓	✓	✓	✓	✓	✓

Pendeltürband STORM

>> GERADLINIG UND FUNKTIONAL

STORM ist ein Pendeltürband mit einstellbarer Nulllage und ist auf den letzten Zentimetern selbstschliessend.





- Pendeltürband
- beidseitig 90° öffnend
- einseitige Befestigungslasche
- Langlochverstellung mit Abdeckkappe
- stufenlose Nulllageneinstellung
- auf den letzten Zentimetern selbstschliessend
- Dichtprofil beschlagseitig im Bandbereich unterbrochen
- Tragfähigkeit (2 Bänder) **42kg**
entsprechen einem Glastürrügel von
1000 x 2000 mm bei einer Glasdicke von 8 mm



PENDELTÜR BAND STORM

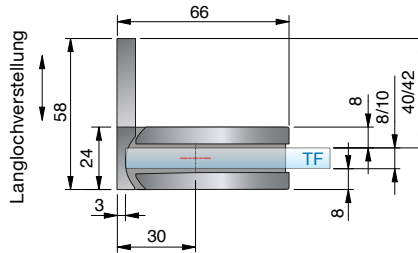

Glasbearbeitung ohne
Dichtprofil für 8mm Glas

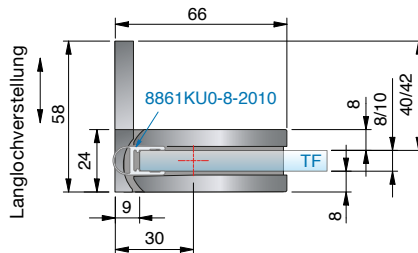
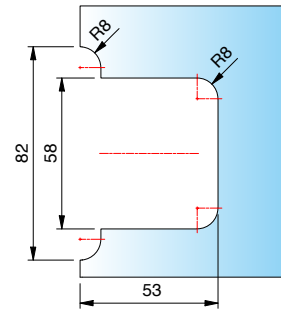

Glasbearbeitung mit Dichtprofil
8861KU0-8 für 8mm Glas

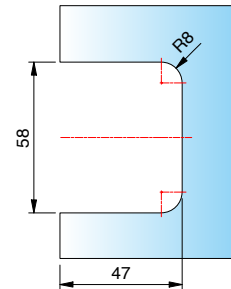

Pendeltürband



Art.-Nr.	Oberfläche	Glasdicke	Artikelbezeichnung	Merkmale
8320MS7 8320MS135	glanzverchromt tiefschwarz matt	8/10 mm	Duschpendeltürband STORM Glas-Wand 90°, beidseitig 90° öffnend	Nulllage einstellbar, Langlochverstellung mit Abdeckkappe, einseitige Wandbefestigung, Tragkraft/Paar: 42kg



GLASSYSTEME

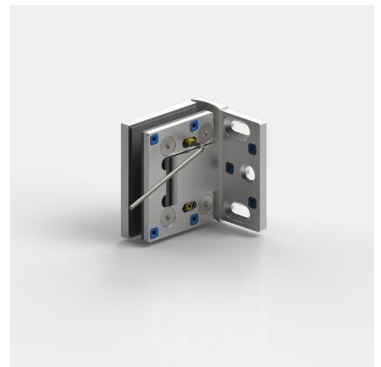
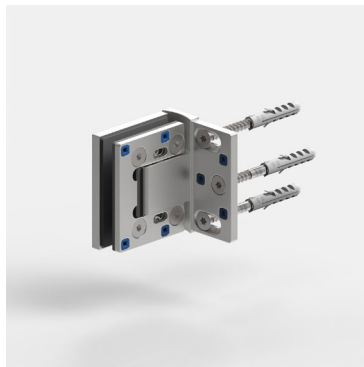
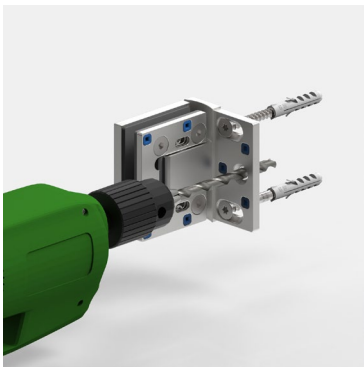
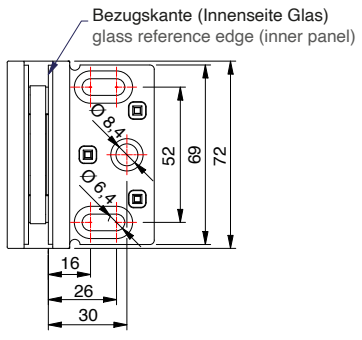
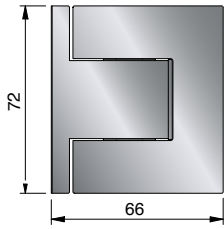

Montage mit dritter Befestigungsbohrung und verstellbarer Nulllage

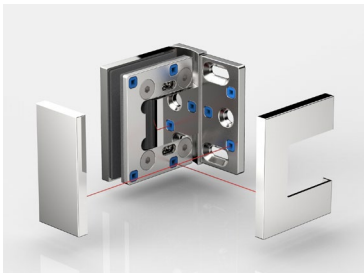

PENDELTÜR BAND STORM

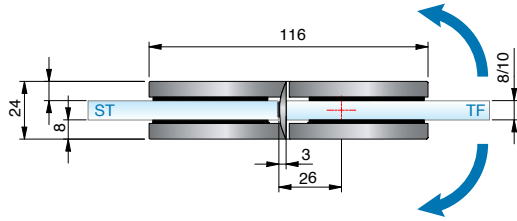

Glasbearbeitung ohne Dichtprofil für 8mm Glas

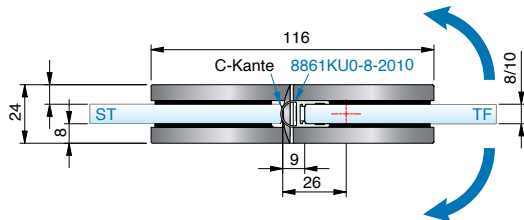
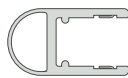
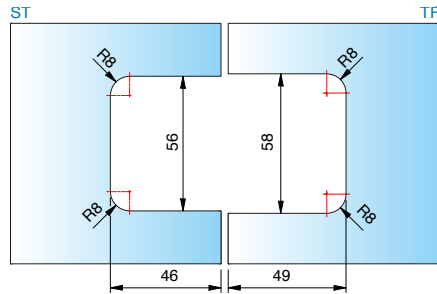

Glasbearbeitung mit Dichtprofil 8861KU0-8 für 8 mm Glas

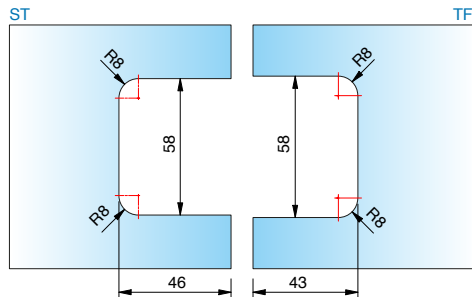

Pendeltürband



Art.-Nr.	Oberfläche	Glasdicke	Artikelbezeichnung	Merkmale
8322MS7 8322MS135	glanzverchromt tiefschwarz matt	8/10 mm	Duschpendeltürband STORM Glas-Glas 180°, beidseitig 90° öffnend	Nulllage einstellbar, Tragkraft/Paar: 42kg



GLASSYSTEME

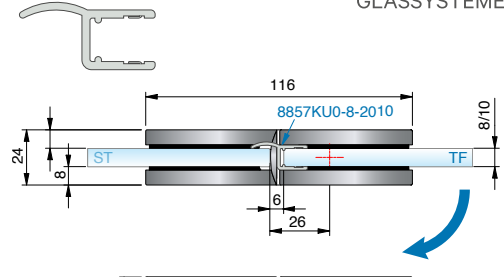
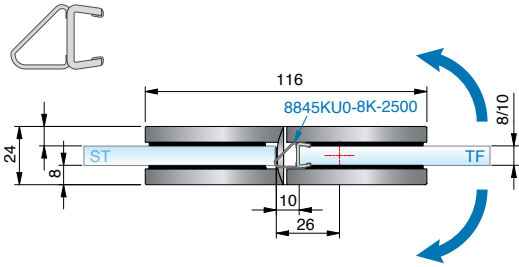

Glasbearbeitung mit Dichtprofil 8845KU0-8 für 8 mm Glas

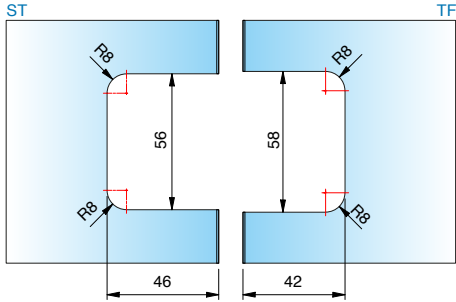

Glasbearbeitung mit Dichtprofil 8857KU0-8 für 8 mm Glas

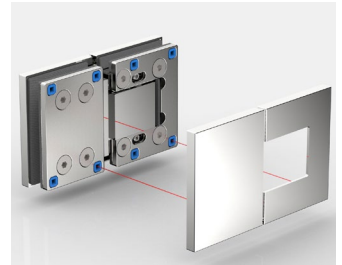
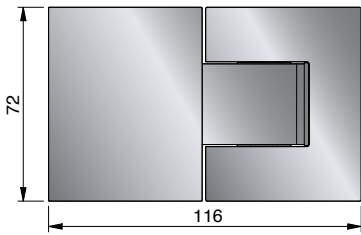
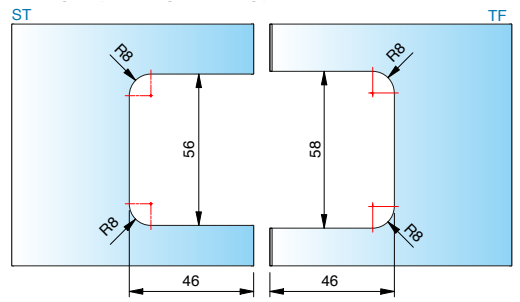

verstellbare Nulllage



Öffnungswinkel 97°

PENDELTÜR BAND STORM

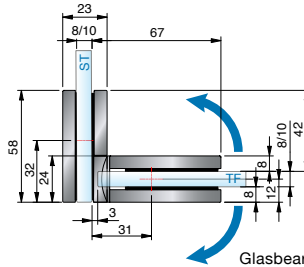

Glasbearbeitung ohne Dichtprofil für 8mm Glas

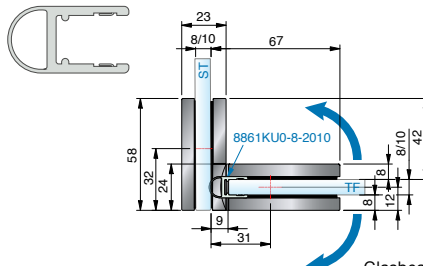
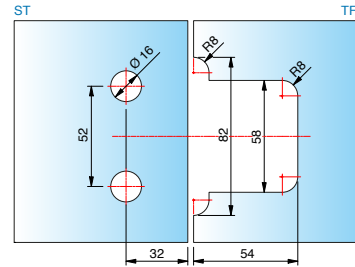

Glasbearbeitung mit Dichtprofil 8861KU0-8 für 8mm Glas

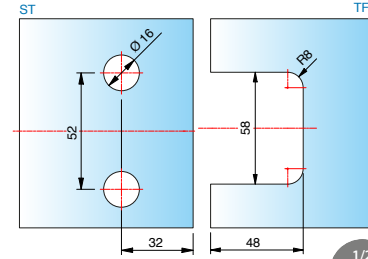

Pendeltürband

Art.-Nr.	Oberfläche	Glasdicke	Artikelbezeichnung	Merkmale
8324MS7 8324MS135	glanzverchromt tiefschwarz matt	8/10 mm	Duschpendeltürband STORM Glas-Glas 90°, beidseitig 90° öffnend	Nulllage einstellbar, Tragkraft/Paar: 42kg



GLASSYSTEME

Glas eingerückt (am Beispiel 30mm Einrückmaß)

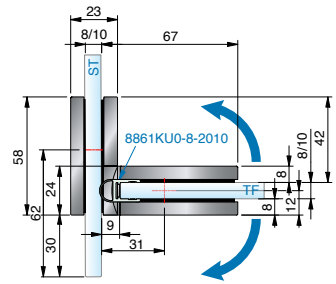
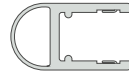
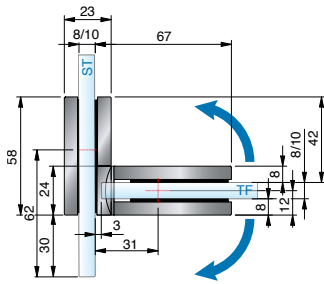

Glasbearbeitung ohne Dichtprofil für 8mm Glas

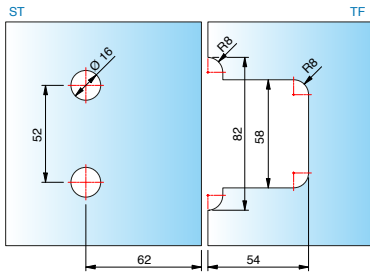

Glasbearbeitung mit Dichtprofil 8861KU0-8 für 8 mm Glas

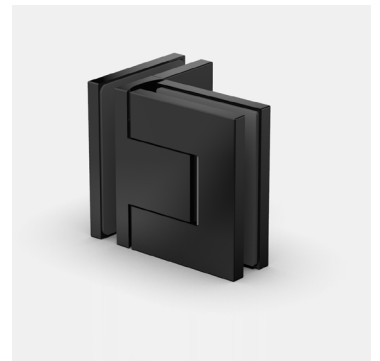
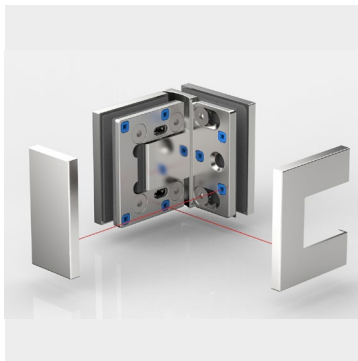
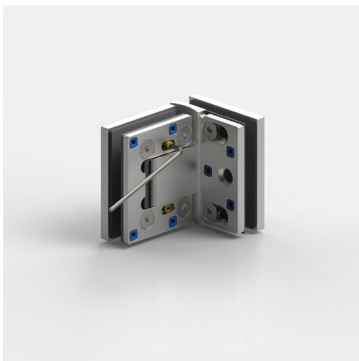
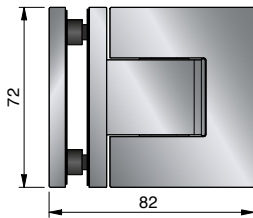
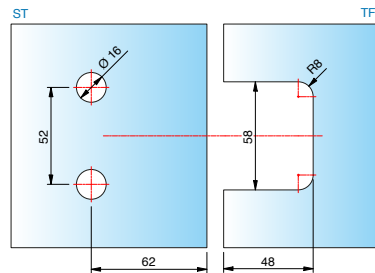

verstellbare Nulllage

WINKELVERBINDER STORM



Langlochverstellung
adjustable along the
elongated hole

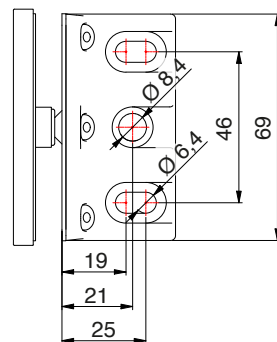
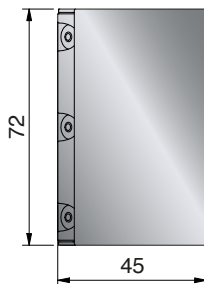
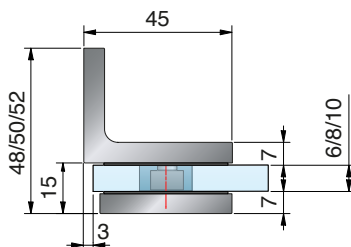

Glasbearbeitung für 8 mm
glass processing for 8 mm

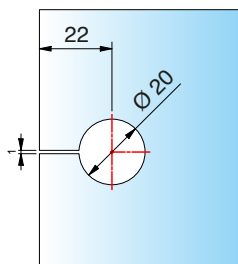

Winkerverbinder



Art.-Nr.	Oberfläche	Glasdicke	Artikelbezeichnung	Merkmale
8328MS7 8328MS135	glanzverchromt tiefschwarz matt	8/10 mm	Winkerverbinder STORM Glas-Wand 90°,	Wandbefestigung mit Langlochverstellung, verdeckte Verschraubung mit Abdeck- kappe

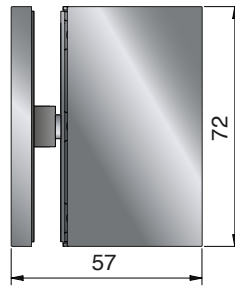
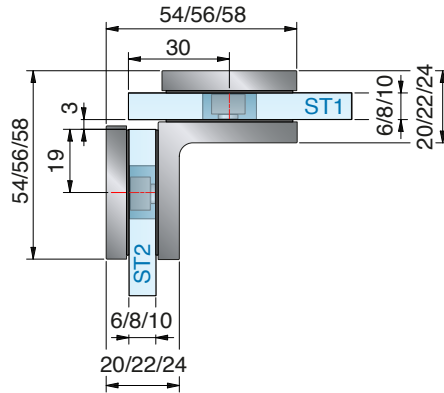
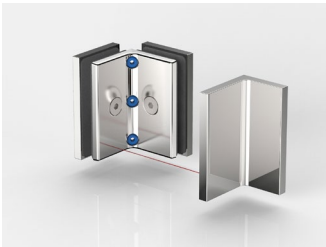

Glasbearbeitung für 8 mm
glass processing for 8 mm

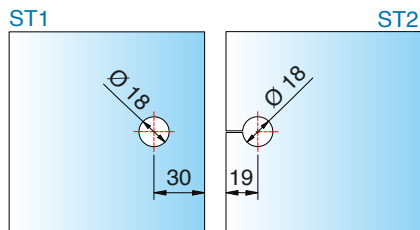

Winkerverbinder



Art.-Nr.	Oberfläche	Glasdicke	Artikelbezeichnung	Merkmale
8329MS7 8329MS135	glanzverchromt tiefschwarz matt	8/10 mm	Winkerverbinder STORM Glas-Glas 90°,	mit Abdeckkappe, starr

Pendeltürband AMBER



GERADLINIG UND FUNKTIONAL

AMBER ist ein Pendeltürband mit einstellbarer Nulllage und ist auf den letzten Zentimetern selbstschliessend.





- Pendeltürband
- Material: Messing
- Oberfläche: glanzverchromt/schwarz matt
- Nulllage einstellbar
- Dichtprofil beschlagseitig im Bandbereich unterbrochen
- auf den letzten Zentimetern selbstschliessend
- Tragfähigkeit (2 Bänder): **42 kg**
entsprechen einem Glastürflügel von
1000 x 2000 mm bei einer Glasdicke von 8 mm



PENDELTÜRBAND AMBER

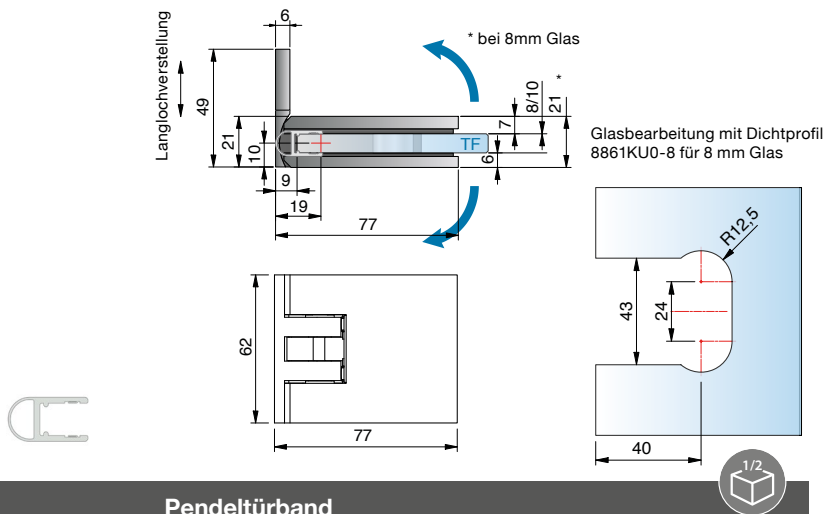
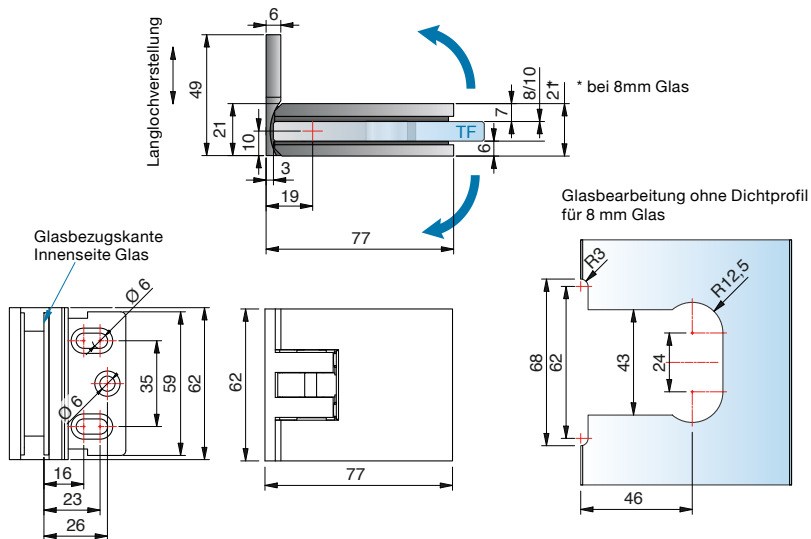

Pendeltürband

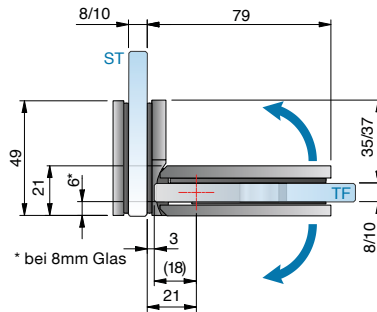
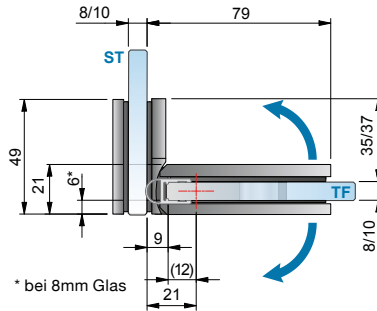
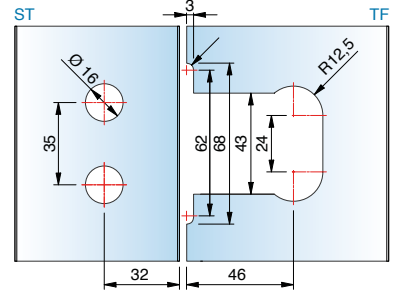
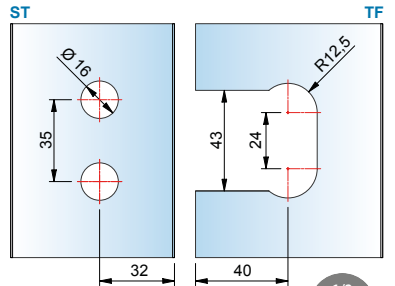

Art.-Nr.	Oberfläche	Glasdicke	Artikelbezeichnung	Merkmale
8242MS7 8242MSPVD35	glanzverchromt schwarz matt	8/10 mm	Duschpendeltürband AMBER Glas-Wand 90°, beidseitig 90° öffnend	Nulllage einstellbar, Langlochverstellung mit Abdeckkappe, einseitige Wandbefestigung, Tragkraft/Paar: 42kg

 Glasbearbeitung ohne Dichtprofil
für 8 mm Glas

 Glasbearbeitung mit Dichtprofil
8861KU0-8 für 8 mm Glas

Pendeltürband

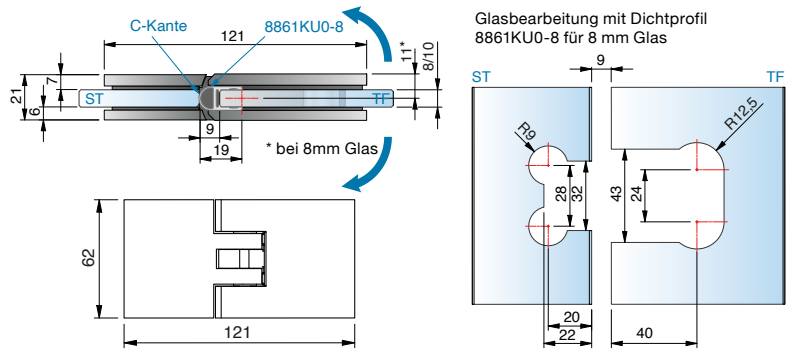
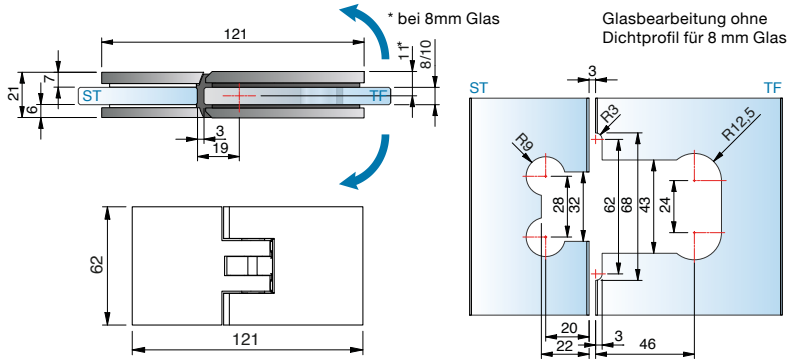

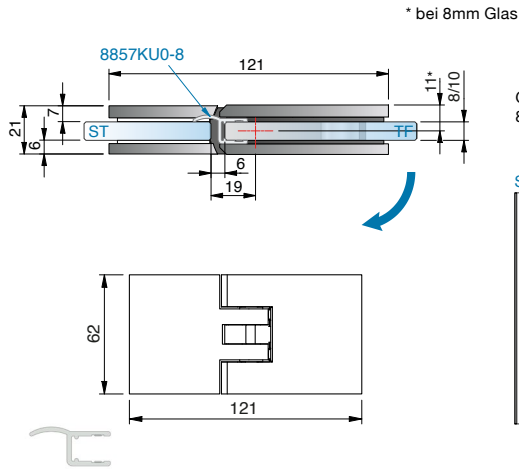
Art.-Nr.	Oberfläche	Glasdicke	Artikelbezeichnung	Merkmale
8244MS7 8244MSPVD35	glanzverchromt schwarz matt	8/10 mm	Duschpendeltürband AMBER Glas-Glas 90°, beidseitig 90° öffnend	Nulllage einstellbar, Tragkraft/Pair: 42kg

PENDELTÜR BAND AMBER



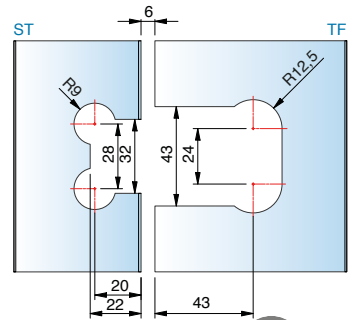

Glasbearbeitung mit Dichtprofil
8857KU0-8 für 8 mm Glas



Pendeltürband

Art.-Nr.	Oberfläche	Glasdicke	Artikelbezeichnung	Merkmale
8243MS7 8243MSPVD35	glanzverchromt schwarz matt	8/10 mm	Duschpendeltürband AMBER Glas-Glas 180°, je nach Dich- tung beidseitig 90° öffnend	Nulllage einstellbar, Tragkraft/Paar: 42kg

WINKELVERBINDER AMBER

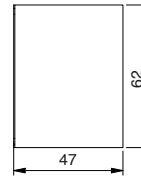
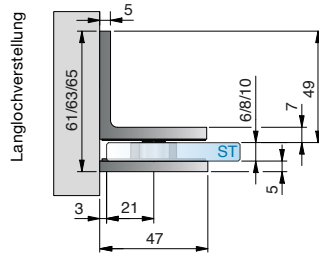

Glasbearbeitung für 6/8/10 mm

Bohrung
Ø 18 mm

Randausschnitt
R35

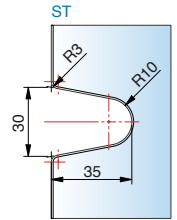
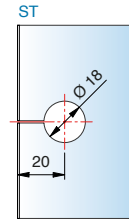

Winkelverbinder

Art.-Nr.	Oberfläche	Glasdicke	Artikelbezeichnung	Merkmale
8246MS7 8246MSPVD35	glanzverchromt schwarz matt	6/8/10 mm	Winkelverbinder AMBER Glas-Wand 90°	Wandbefestigung mit Langlochverstellung, verdeckte Verschraubung mit Abdeck- kappe

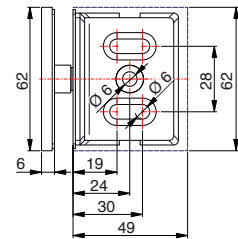
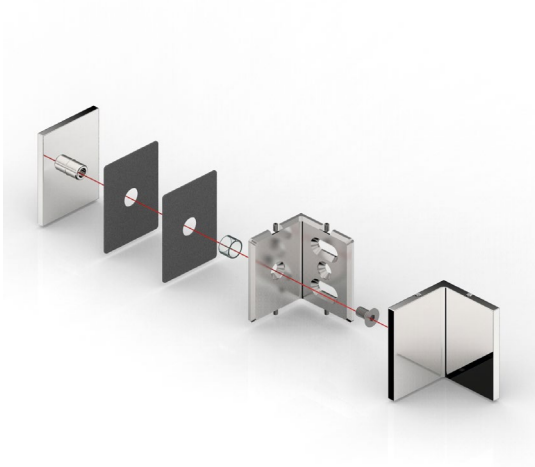

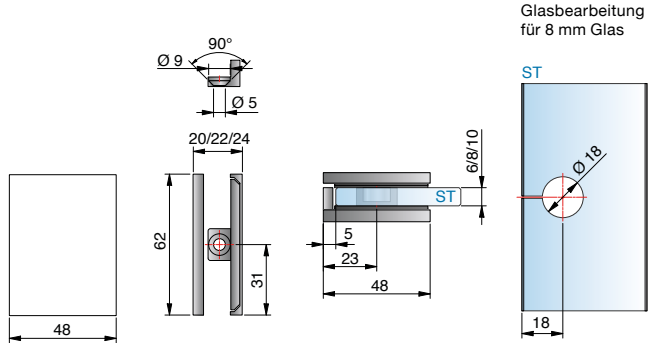

Glasbearbeitung für 8 mm Glas

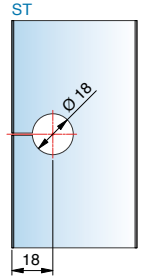

Winkelverbinder

Art.-Nr.	Oberfläche	Glasdicke	Artikelbezeichnung	Merkmale
8247MS7 8247MSPVD35	glanzverchromt schwarz matt	6/8/10 mm	Winkelverbinder AMBER Glas-Wand 90°	ohne Lasche

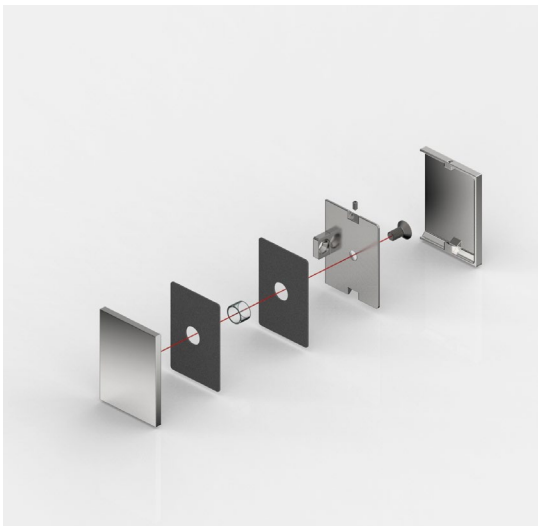

WINKELVERBINDER AMBER

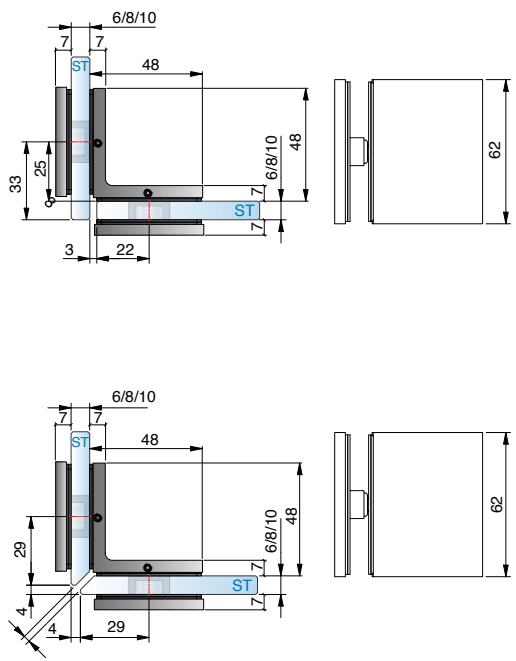

Glasbearbeitung für 8 mm

Bohrung
Ø 18 mm

ST

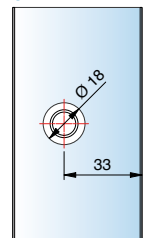

Bohrung
Ø 18 mm

ST

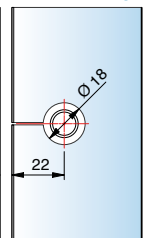

Glasbearbeitung für 8 mm

Bohrung
Ø 18 mm

ST

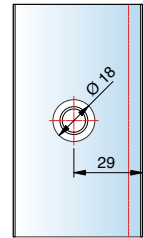

Bohrung
Ø 18 mm

ST

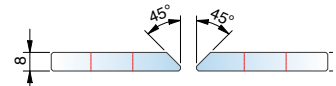
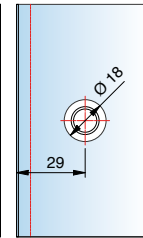

Winkelverbinder

Art.-Nr.	Oberfläche	Glasdicke	Artikelbezeichnung	Merkmale
8248MS7	glanzverchromt	6/8/10 mm	Winkelverbinder AMBER	mit Abdeckkappe, starr
8248MSPVD35	schwarz matt		Glas-Glas 90°	

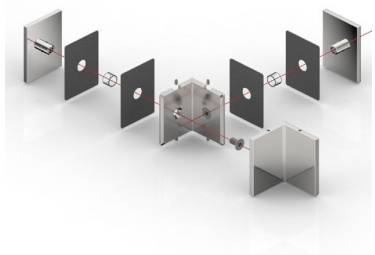

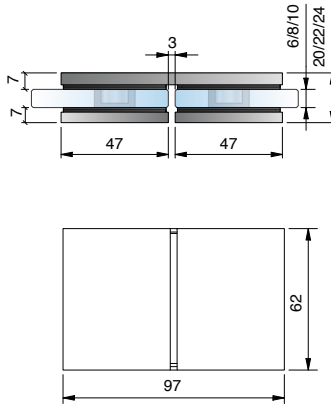

Glasbearbeitung für 8 mm Glas

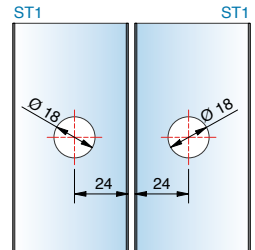

Winkelverbinder

Art.-Nr.	Oberfläche	Glasdicke	Artikelbezeichnung	Merkmale
8249MS7	glanzverchromt	6/8/10 mm	Winkelverbinder AMBER	verdeckte Verschraubung mit Abdeckkappe
8249MSPVD35	schwarz matt		Glas-Glas 180°	

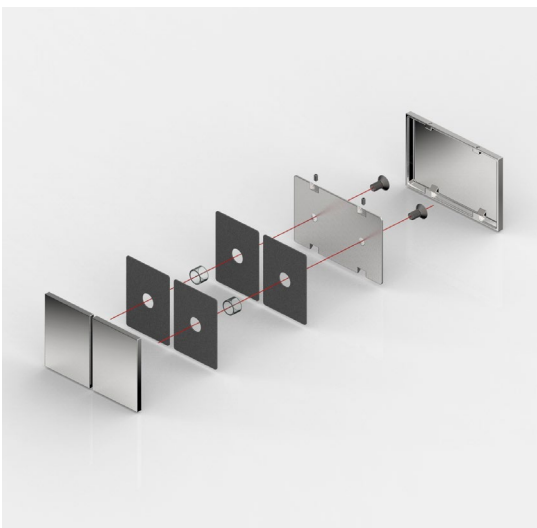

Duschtürband TERO



VIELSEITIG UND GÜNSTIG

TERO ist ein Band von zuverlässiger Funktionalität und zeitlosem Erscheinungsbild. Das Anschlagtürband öffnet sich einseitig nach außen oder innen. Ein Duschband für den Objekt- und Privatbereich. Höchste Qualität zu einem marktgerechten Preis.





- verdeckte Verschraubung mit Abdeckkappe
- einseitig nach außen oder innen hin öffnendes Anschlagtürband
- Montage mit durchgehender Dichtung möglich
- Bandachse außerhalb der Glasflucht positioniert, deshalb ein komplettes Falten der Glaselemente möglich
- Glasdicke: 6, 8 und 10 mm
- Tragfähigkeit (2 Bänder): **40 kg**
entspricht einer maximalen Türflügelgröße von 1000 x 2000 mm bei 8 mm Glasdicke

DUSCHTÜR BAND TERO

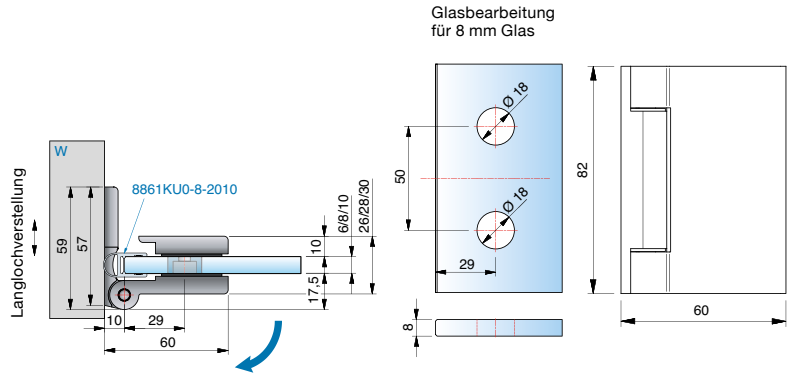

Duschtürband



Art.-Nr.	Oberfläche	Glasdicke	Artikelbezeichnung	Merkmale
8910MS7	glanzverchromt	6/8/10 mm	Duschtürband TERO Glas-Wand 90°	90° nach aussen öffnend, verdeckte Verschraubung mit Abdeckkappe, Wandbefestigung mit Abdeckkappe, innen mit Langlochverstellung, durchgehende Dichtung

Tragkraft von zwei Bändern: 40kg
maximale Türbreite: 1000 mm

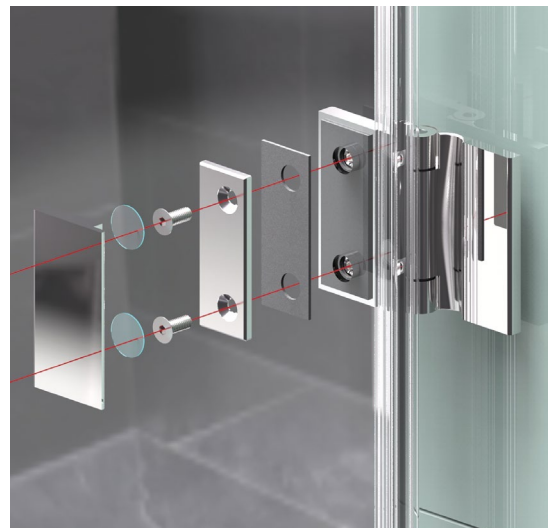

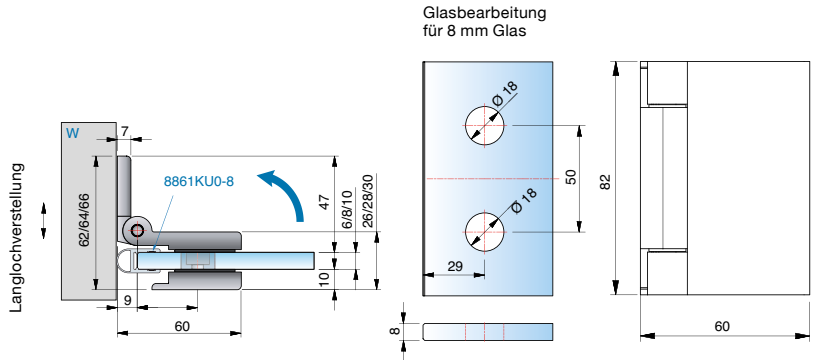

Duschtürband



Art.-Nr.	Oberfläche	Glasdicke	Artikelbezeichnung	Merkmale
8911MS7	glanzverchromt	6/8/10 mm	Duschtürband TERO Glas-Wand 90°	90° nach innen öffnend, verdeckte Verschraubung mit Abdeckkappe, Wandbefestigung mit Abdeckkappe, innen mit Langlochverstellung, durchgehende Dichtung

Tragkraft von zwei Bändern: 40kg
maximale Türbreite: 1000 mm

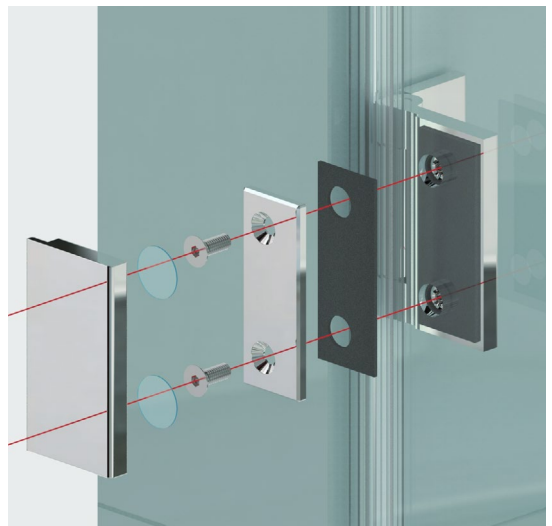

DUSCHTÜR BAND TERO

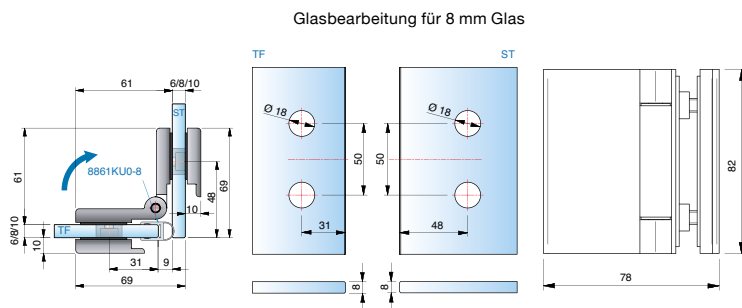

Duschtürband



Art.-Nr.	Oberfläche	Glasdicke	Artikelbezeichnung	Merkmale
8912MS7	glanzverchromt	6/8/10 mm	Duschtürband TERO Glas-Glas 90°	90° nach innen öffnend, verdeckte Verschraubung mit Abdeckkappe, durchgehende Dichtung

Tragkraft von zwei Bändern: 40kg
maximale Türbreite: 1000 mm

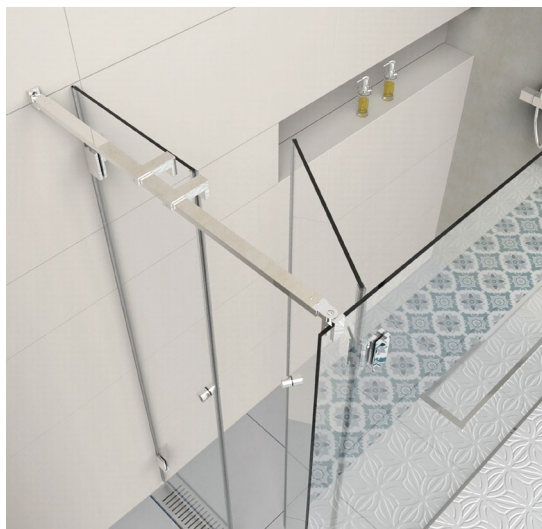



180° nach außen öffnend

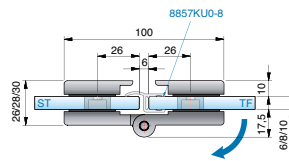

Glasbearbeitung für 8 mm Glas

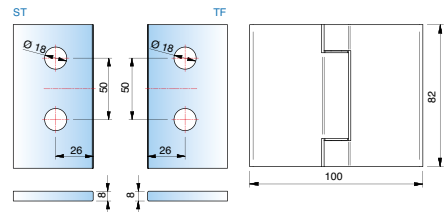

180° nach innen öffnend

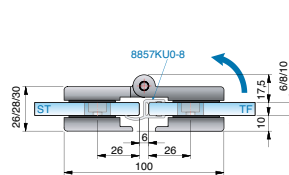

Glasbearbeitung für 8 mm Glas

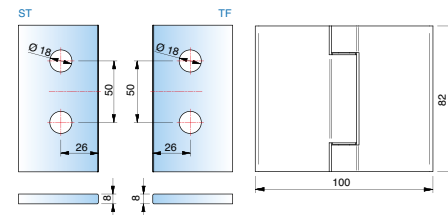

Duschtürband

Art.-Nr.	Oberfläche	Glasdicke	Artikelbezeichnung	Merkmale
8912MS7	glanzverchromt	6/8/10 mm	Duschtürband TERO Glas-Glas 180°	verdeckte Verschraubung mit Abdeckkappe, durchgehende Dichtung

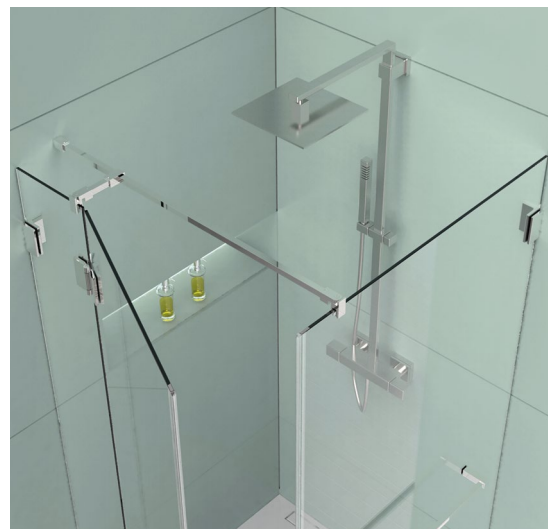
Tragkraft von zwei Bändern: 40kg
maximale Türbreite: 1000 mm

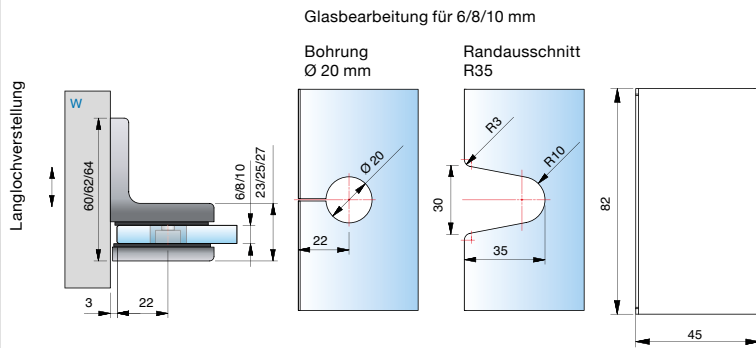

WINKELVERBINDER TERO



Winkelverbinder

Art.-Nr.	Oberfläche	Glasdicke	Artikelbezeichnung	Merkmale
8915MS7	glanzverchromt	6/8/10 mm	Winkelverbinder TERO Glas-Wand 90°	Wandbefestigung mit Langlochverstellung, verdeckte Verschraubung mit Abdeckkappe

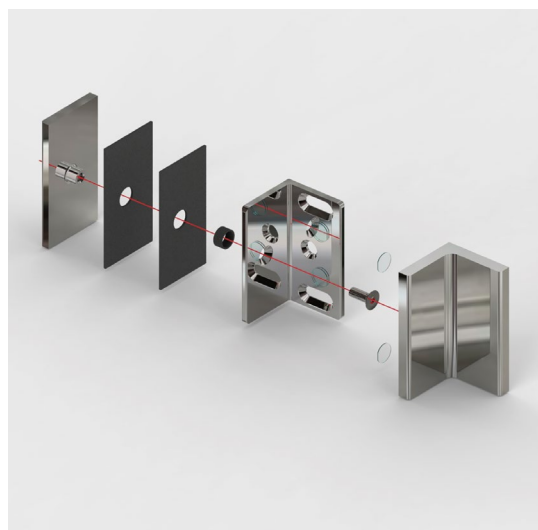

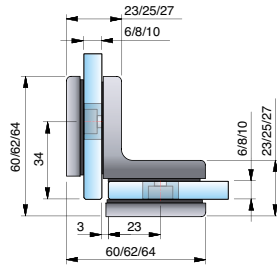

Glasbearbeitung für 8 mm Glas

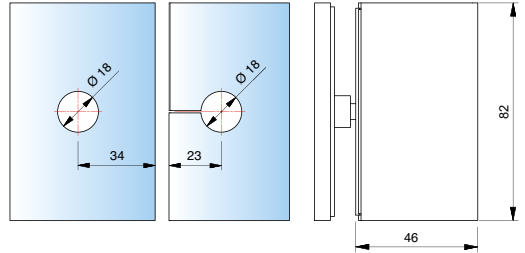

Winkelverbinder

Art.-Nr.	Oberfläche	Glasdicke	Artikelbezeichnung	Merkmale
8916MS7	glanzverchromt	6/8/10 mm	Winkelverbinder TERO Glas-Glas 90°	verdeckte Verschraubung mit Abdeckkappe

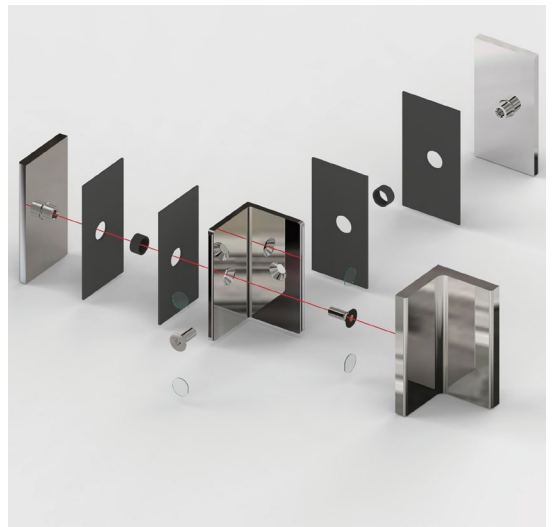

Pendeltürband SUNO



ZUVERLÄSSIG UND LEISTUNGSSTARK

SUNO ist ein Pendeltürband mit einstellbarer Nulllage. Es ist vielseitig einsetzbar und kostengünstig.





- Pendeltürband
- Material: Messing
- Oberfläche: glanzverchromt
- Nulllage einstellbar
- Tragfähigkeit (2 Bänder): **30 kg**
entsprechen einem Glastürflügel von
750 x 2000 mm bei einer Glasdicke von 8 mm

PENDELTÜR BAND SUNO



Glasbearbeitung ohne Dichtprofil
für 8 mm Glas

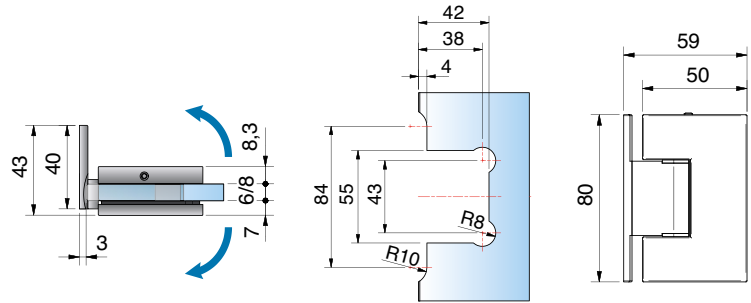

Glasbearbeitung mit Dichtprofil
8861KU0-8 für 8 mm Glas

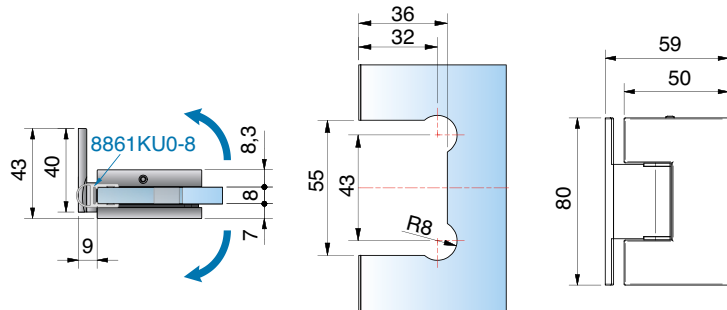

Pendeltürband

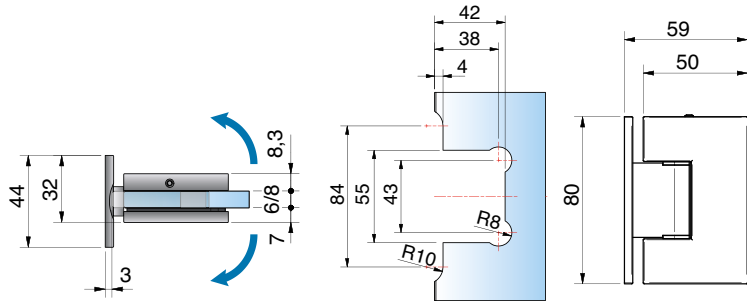
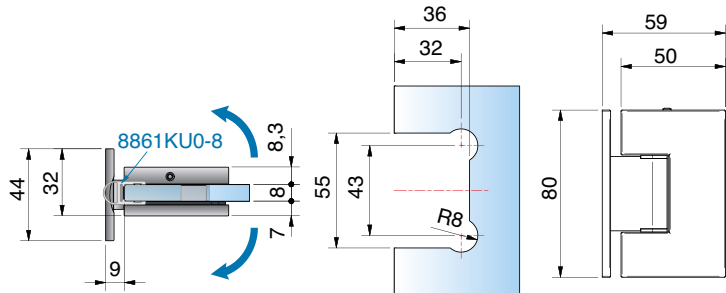

Art.-Nr.	Oberfläche	Glasdicke	Artikelbezeichnung	Merkmale
8920MS7	glanzverchromt	6/8 mm	Duschpendeltürband SUNO Glas-Wand 90°, beidseitig 90° öffnend	Nulllage einstellbar, Verschraubung Glas mit Abdeckkappe, einseitige Wandbefestigung für 3 Schrauben, Tragkraft/Paar: 30kg

 Glasbearbeitung ohne Dichtprofil
für 8 mm Glas

 Glasbearbeitung mit Dichtprofil
8861KU0-8 für 8 mm Glas

Pendeltürband



Art.-Nr.	Oberfläche	Glasdicke	Artikelbezeichnung	Merkmale
8921MS7	glanzverchromt	6/8 mm	Duschpendeltürband SUNO Glas-Wand 90°, beidseitig 90° öffnend	Nulllage einstellbar, Verschraubung Glas mit Abdeckkappe, beidseitige Wandbefestigung für 4 Schrauben, Tragkraft/Paar: 30kg,

PENDELTÜR BAND SUNO



Glasbearbeitung ohne Dichtprofil
für 8 mm Glas

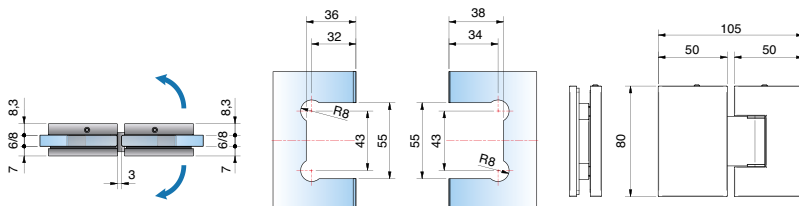

Glasbearbeitung mit Dichtprofil
8857KU0-8 für 8 mm Glas

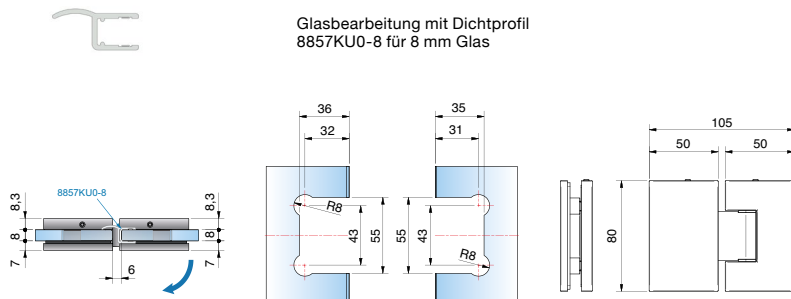

Glasbearbeitung mit Dichtprofil
8861KU0-8 für 8 mm Glas

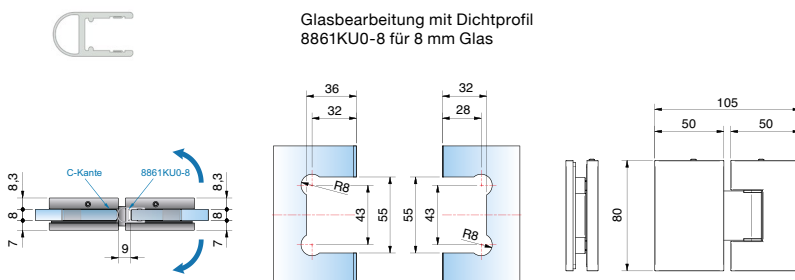

Pendeltürband

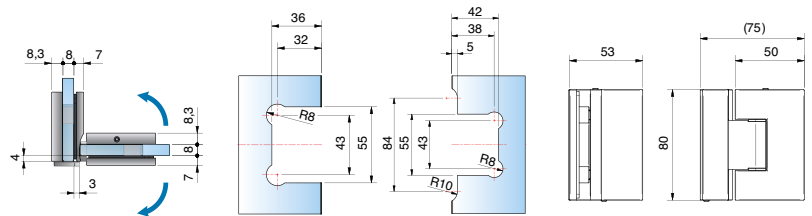
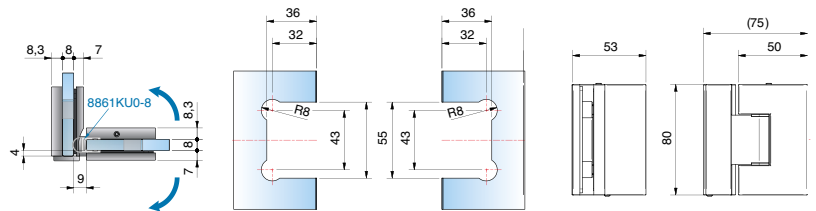

Art.-Nr.	Oberfläche	Glasdicke	Artikelbezeichnung	Merkmale
8922MS7	glanzverchromt	6/8 mm	Duschpendeltürband SUNO Glas-Glas 180°, beidseitig 90° öffnend	Nulllage einstellbar, Tragkraft/Pair: 30kg, Verschraubung Glas mit Abdeckkappe

 Glasbearbeitung ohne
Dichtprofil für 8 mm Glas

 Glasbearbeitung mit Dichtprofil
8861KU0-8 für 8 mm Glas

Pendeltürband

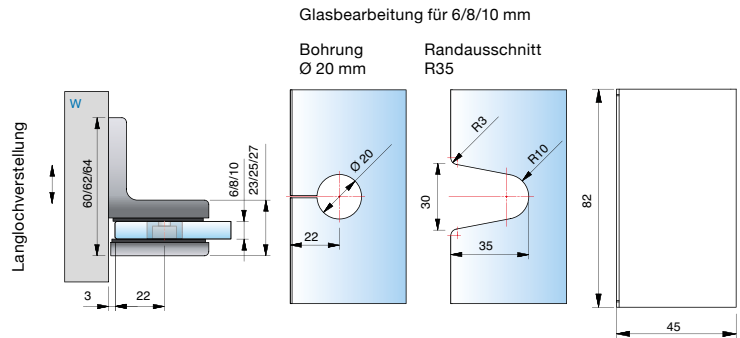
Art.-Nr.	Oberfläche	Glasdicke	Artikelbezeichnung	Merkmale
8923MS7	glanzverchromt	6/8 mm	Duschpendeltürband SUNO Glas-Glas 90°, beidseitig 90° öffnend	Nulllage einstellbar, Tragkraft/Pair: 30kg, Verschraubung Glas mit Abdeckkappe

WINKELVERBINDER TERO



Winkelverbinder



Art.-Nr.	Oberfläche	Glasdicke	Artikelbezeichnung	Merkmale
8915MS7	glanzverchromt	6/8/10 mm	Winkelverbinder TERO Glas-Wand 90°	Wandbefestigung mit Langlochverstellung, verdeckte Verschraubung mit Abdeckkappe

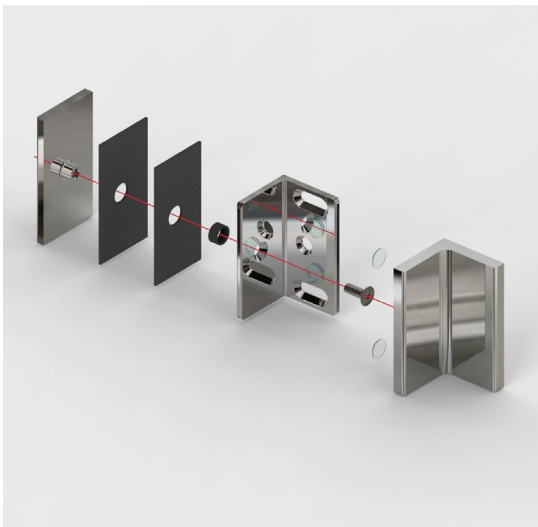

Glasbearbeitung für 8 mm Glas

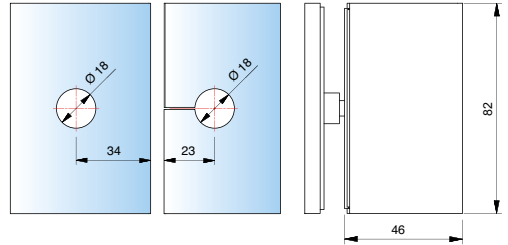
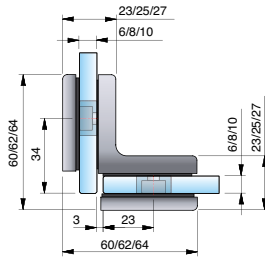

Winkelverbinder

Art.-Nr.	Oberfläche	Glasdicke	Artikelbezeichnung	Merkmale
8916MS7	glanzverchromt	6/8/10 mm	Winkelverbinder TERO Glas-Glas 90°	verdeckte Verschraubung mit Abdeckkappe



Pendeltürband LUNO



STARK UND VIELFÄLTIG

LUNO ist ein Pendeltürband mit selbst-schließender Funktion ab 25°. Durch die hohe Tragkraft sind auch größere Duschanwendungen möglich.

- Pendeltürband
- Material: Messing
- Oberfläche: glanzverchromt
- schließt ab 25° automatisch,
- Tragfähigkeit (2 Bänder): 50 kg
- entsprechen einem Glastürflügel von 1000 x 2000 mm bei einer Glasdicke von 10 mm

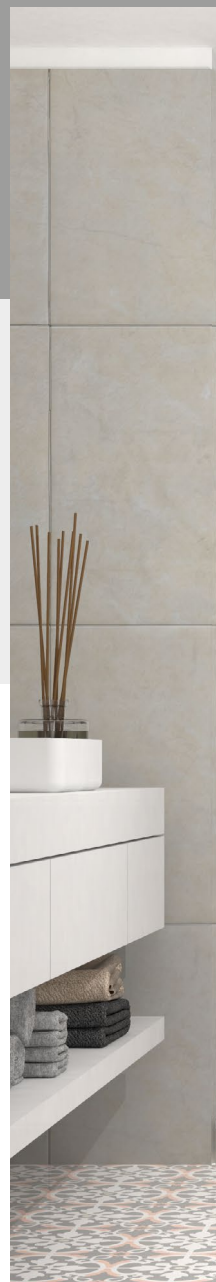



GLASSYSTEME



PENDELTÜR BAND LUNO

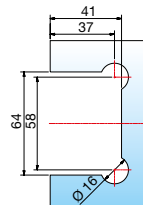
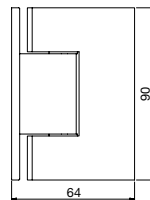
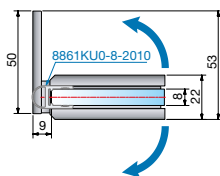

Glasbearbeitung für 8 mm Glas



Pendeltürband

Art.-Nr.	Oberfläche	Glasdicke	Artikelbezeichnung	Merkmale
8450MS7	glanzverchromt	8/10/12 mm	Duschpendeltürband LUNO Glas-Wand 90°, beidseitig 90° öffnend	schließt ab 25° automatisch, Tragkraft/Paar: 50kg

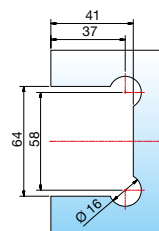
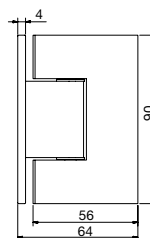
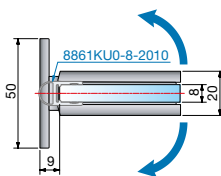

Glasbearbeitung für 8 mm Glas



Pendeltürband

Art.-Nr.	Oberfläche	Glasdicke	Artikelbezeichnung	Merkmale
8452MS7	glanzverchromt	8/10/12 mm	Duschpendeltürband LUNO Glas-Wand 90°, beidseitig 90° öffnend	schließt ab 25° automatisch, Tragkraft/Paar: 50kg

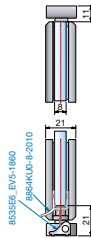

Glasbearbeitung für 8 mm Glas

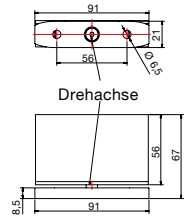
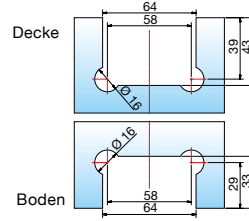

Pendeltürband

Art.-Nr.	Oberfläche	Glasdicke	Artikelbezeichnung	Merkmale
8454MS7	glanzverchromt	8/10/12 mm	Duschpendeltürband LUNO Glas-Boden/ Glas Decke 360°, beidseitig öffnend	schließt ab 25° automatisch, Tragkraft/Paar: 50kg

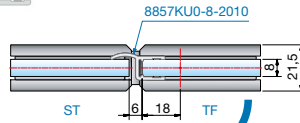
PENDELTÜR BAND LUNO

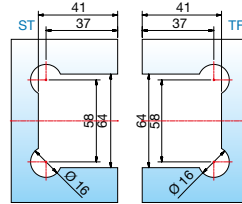

Glasbearbeitung für 8 mm Glas



Bei der Verwendung von Dichtprofil 8857KU0 ist das Band nur einseitig nach außen öffnend.

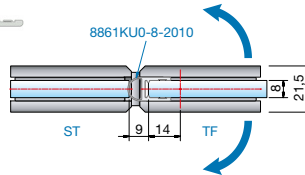
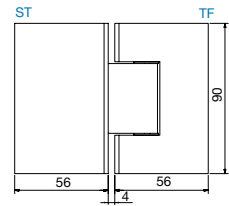

Glasbearbeitung für 8 mm Glas

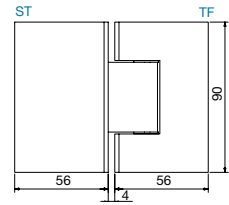
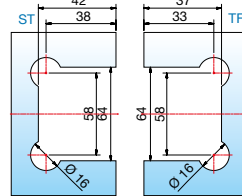

Pendeltürband



Art.-Nr.	Oberfläche	Glasdicke	Artikelbezeichnung	Merkmale
8456MS7	glanzverchromt	8/10/12 mm	Duschpendeltürband LUNO Glas-Glas 180°, beidseitig 90° öffnend	schließt ab 25° automatisch, Tragkraft/Paar: 50kg

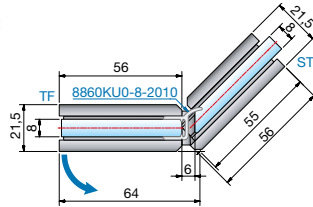

Glasbearbeitung für 8 mm Glas

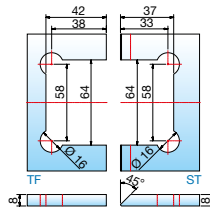

Bei der Verwendung von Dichtprofil 8860KU0 ist das Band nur einseitig nach außen öffnend.

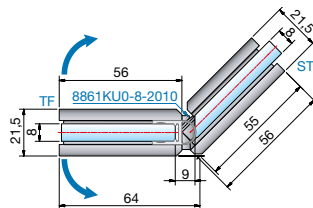
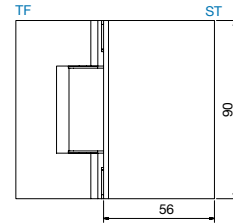

Glasbearbeitung für 8 mm Glas

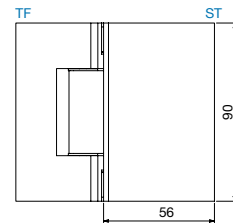
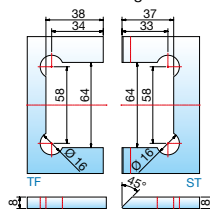

Pendeltürband



Art.-Nr.	Oberfläche	Glasdicke	Artikelbezeichnung	Merkmale
8458MS7	glanzverchromt	8/10/12 mm	Duschpendeltürband LUNO Glas-Glas 135°, beidseitig 90° öffnend	schließt ab 25° automatisch, Tragkraft/Paar: 50kg

PENDELTÜR BAND/ WINKELVERBINDER LUNO

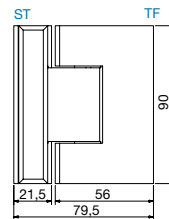
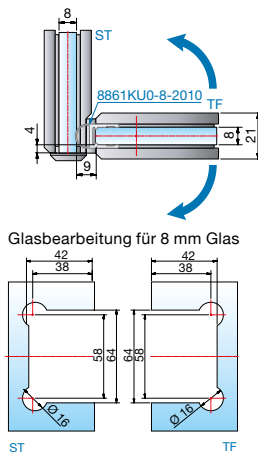

Pendeltürband

Art.-Nr.	Oberfläche	Glasdicke	Artikelbezeichnung	Merkmale
8460MS7	glanzverchromt	8/10/12 mm	Duschpendeltürband LUNO Glas-Glas 90°, beidseitig 90° öffnend	schließt ab 25° automatisch, Tragkraft/Paar: 50kg

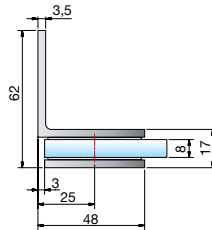

Glasbearbeitung für 8/10/12 mm Glas

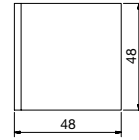
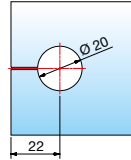
Winkelverbinder

Art.-Nr.	Oberfläche	Glasdicke	Artikelbezeichnung	Merkmale
8462MS7	glanzverchromt	8/10/12 mm	Winkelverbinder LUNO, Glas-Wand 90°	einseitige Befestigungsglasche

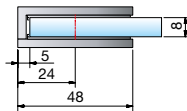

Glasbearbeitung für 8/10/12 mm Glas

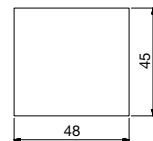
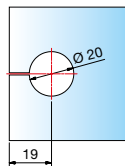

Winkelverbinder

Art.-Nr.	Oberfläche	Glasdicke	Artikelbezeichnung	Merkmale
8464MS7	glanzverchromt	8/10/12 mm	Winkelverbinder LUNO, Glas-Wand 90°	ohne Befestigungsglasche

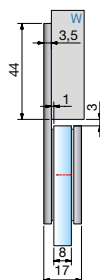
WINKELVERBINDER LUNO

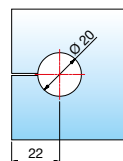

Glasbearbeitung für
8/10/12 mm Glas



Winkelverbinder

Art.-Nr.	Oberfläche	Glasdicke	Artikelbezeichnung	Merkmale
8466MS7	glanzverchromt	8/10/12 mm	Längsverbinder LUNO, Glas-Wand 180°	-

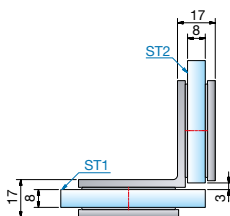

Glasbearbeitung für 8 mm Glas

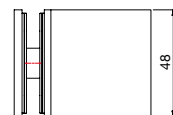
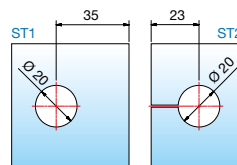

Winkelverbinder

Art.-Nr.	Oberfläche	Glasdicke	Artikelbezeichnung	Merkmale
8468MS7	glanzverchromt	8/10/12 mm	Winkelverbinder LUNO, Glas-Glas 90°	-

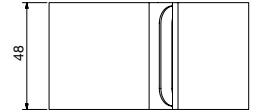
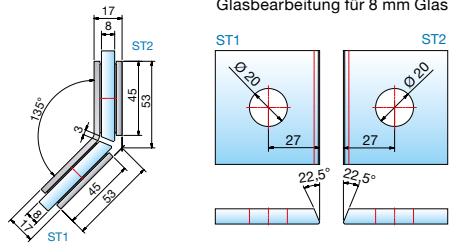

Winkelverbinder

Art.-Nr.	Oberfläche	Glasdicke	Artikelbezeichnung	Merkmale
8470MS7	glanzverchromt	8/10/12 mm	Winkelverbinder LUNO, Glas-Glas 135°	-

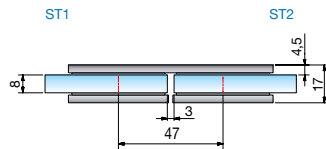

Glasbearbeitung für 8/10/12 mm Glas

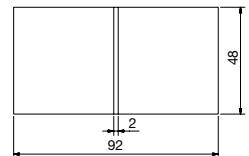
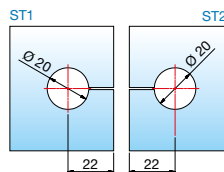

Winkelverbinder

Art.-Nr.	Oberfläche	Glasdicke	Artikelbezeichnung	Merkmale
8472MS7	glanzverchromt	8/10/12 mm	Winkelverbinder LUNO, Glas-Glas 180°	-

Duschen-Zubehör

FUNKTIONAL UND SCHÖN

>> Das besondere an unserem Zubehör ist die Funktionalität und das auf unsere Duschbeschlagserien abgestimmte Design.

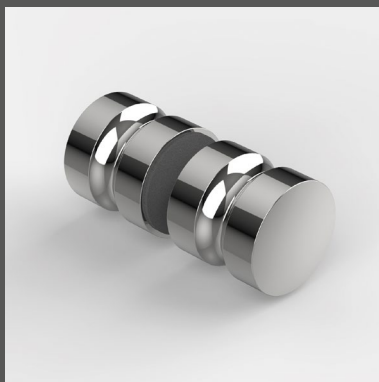
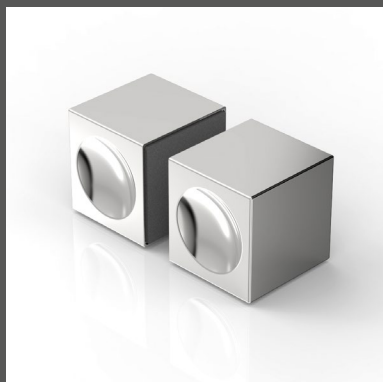
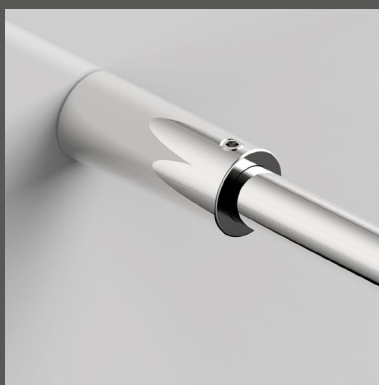
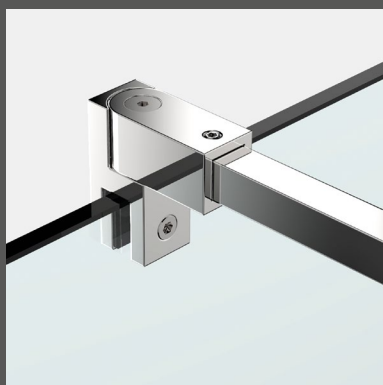

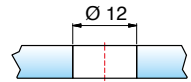
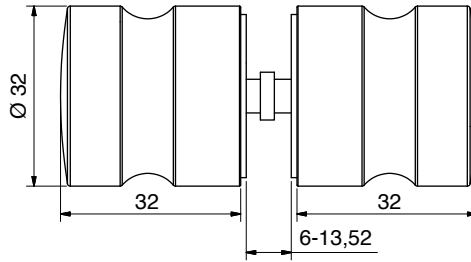

1/1

Glastürknopf beidseitig

Art.-Nr.	Oberfläche	Glasdicke
8288E3/50 8288E6C35	glanzverchromt schwarz matt	6-12 mm

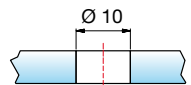
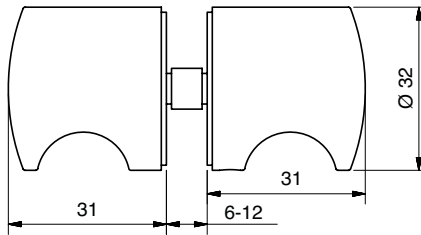
 ■ DESIGNED
 ■ IN
 ■ GERMANY

1/1

Glastürknopf beidseitig

Art.-Nr.	Oberfläche	Glasdicke
8282MS7	glanzverchromt	6-12 mm

 ■ DESIGNED
 ■ IN
 ■ GERMANY

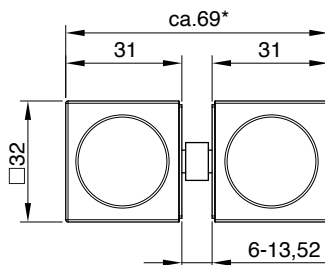
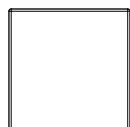

*Bei 8 mm Glas



Glastürgriff beidseitig

Art.-Nr.	Oberfläche	Glasdicke
8378ZN5	glanzverchromt	6-10 mm

DESIGNED
IN
GERMANY

ZUBEHÖR HANDTUCHHALTER

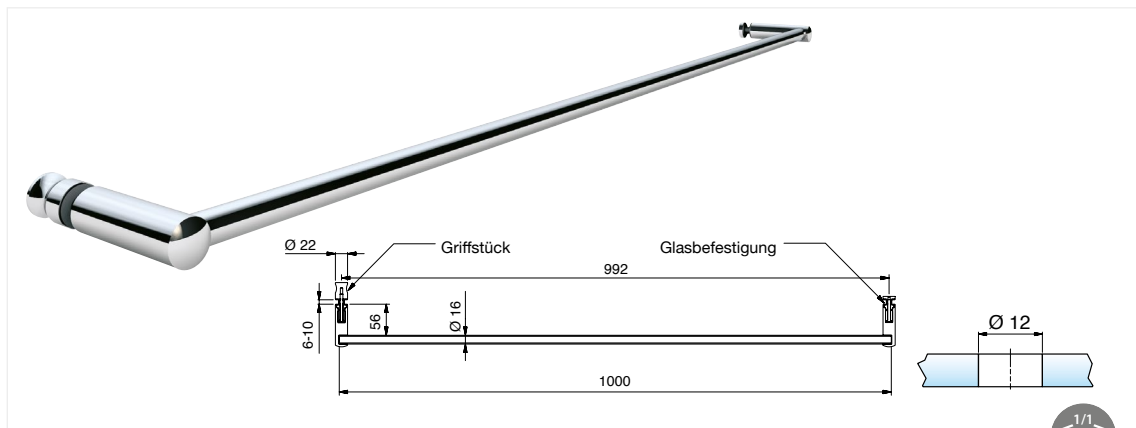

Handtuchhalter für Glas



Mit Glasbefestigung und Griffstück
Rohrlänge (1000 mm) beliebig kürzbar

Art.-Nr.	Oberfläche	Glasdicke
8669MS7-1000	glanzverchromt*	6-10 mm

DESIGNED
IN
GERMANY

*Rohr Edelstahl poliert

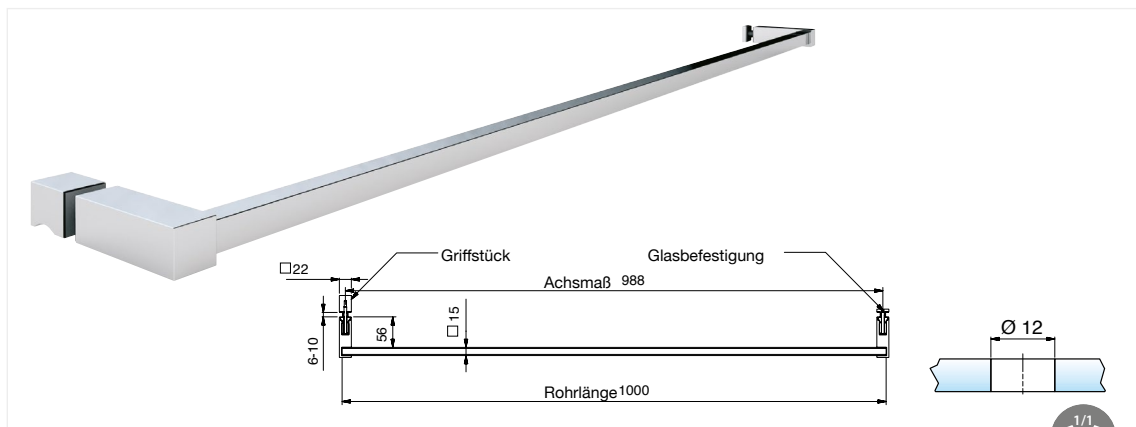

Handtuchhalter für Glas



Mit Glasbefestigung und Griffstück
Rohrlänge (1000 mm) beliebig kürzbar

Art.-Nr.	Oberfläche	Glasdicke
8671MS7-1000	glanzverchromt*	6-10 mm

DESIGNED
IN
GERMANY

*Rohr Edelstahl poliert

ZUBEHÖR STABILISATIONSSTANGE RUND

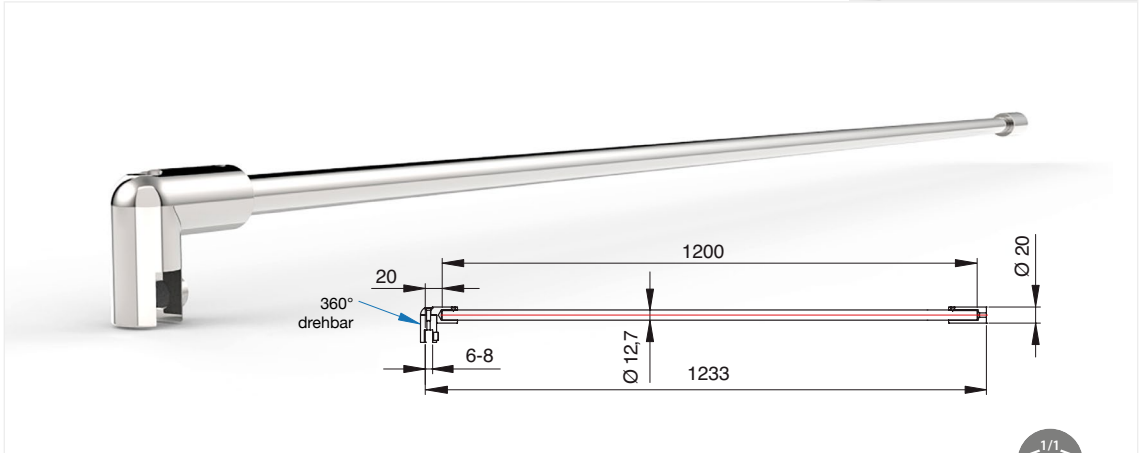

Stabilisationsstange Glas-Wand

Rohrlänge 1200 mm, beliebig kürzbar

Art.-Nr.	Oberfläche	Glasdicke
8661MS7-1200	glanzverchromt*	6-8 mm
8661MSPVD35-1200	schwarz matt	

DESIGNED
IN
GERMANY

*Rohr Edelstahl poliert



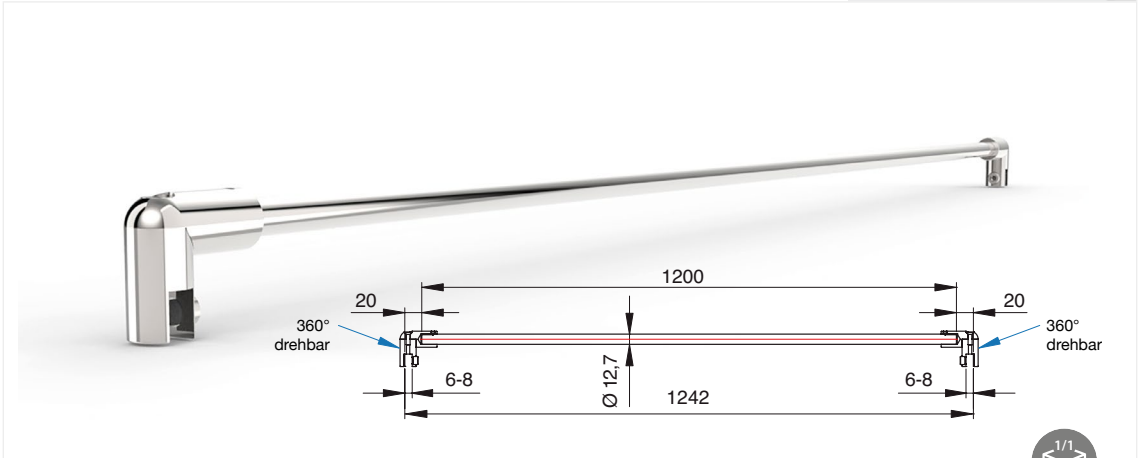

Stabilisationsstange Glas-Glas

Rohrlänge 1200 mm, beliebig kürzbar

Art.-Nr.	Oberfläche	Glasdicke
8663MS7-1200	glanzverchromt*	6-8 mm

DESIGNED
IN
GERMANY

*Rohr Edelstahl poliert



ZUBEHÖR STABILISATIONSSTANGE RUND

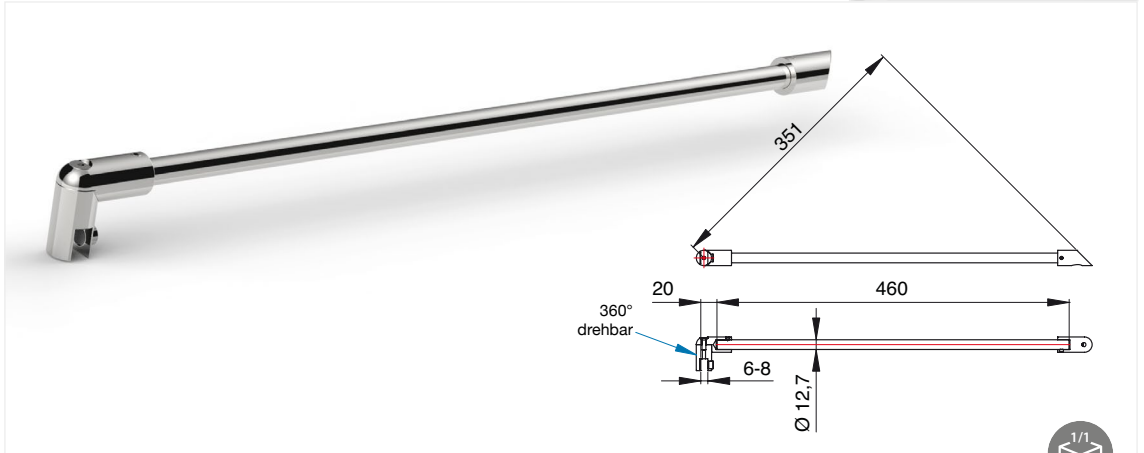

Stabilisationsstange Glas-Wand 45°

Rohrlänge 460 mm, beliebig kürzbar

Art.-Nr.	Oberfläche	Glasdicke
8662MS7-460	glanzverchromt*	6-8 mm
8662MSPVD35-460	schwarz matt	

DESIGNED
IN
GERMANY

*Rohr Edelstahl poliert



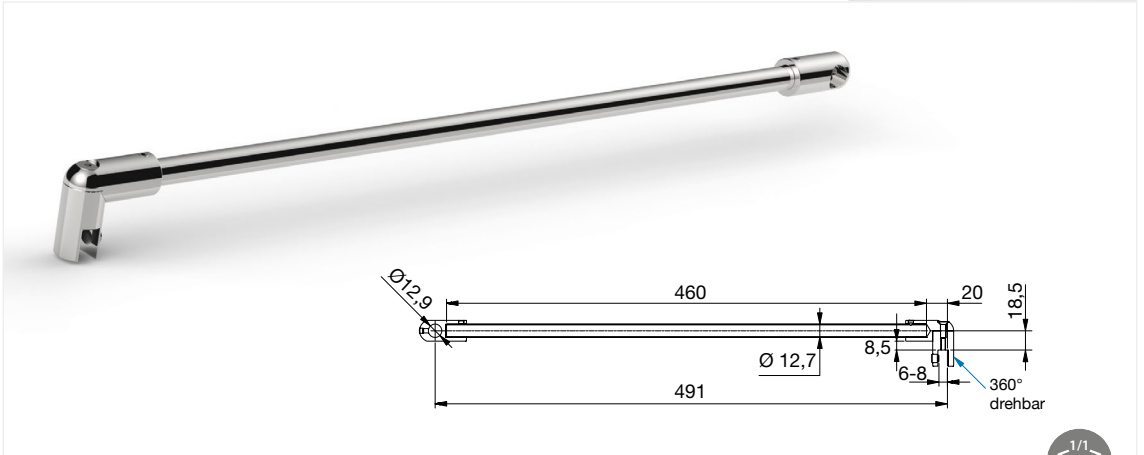

Stabilisationsstange Glas-T-Stück-Verbinder

Rohrlänge 460 mm, beliebig kürzbar

Art.-Nr.	Oberfläche	Glasdicke
8667MS7-460	glanzverchromt*	6-8 mm

DESIGNED
IN
GERMANY

*Rohr Edelstahl poliert



ZUBEHÖR STABILISATIONSSTANGE ECKIG

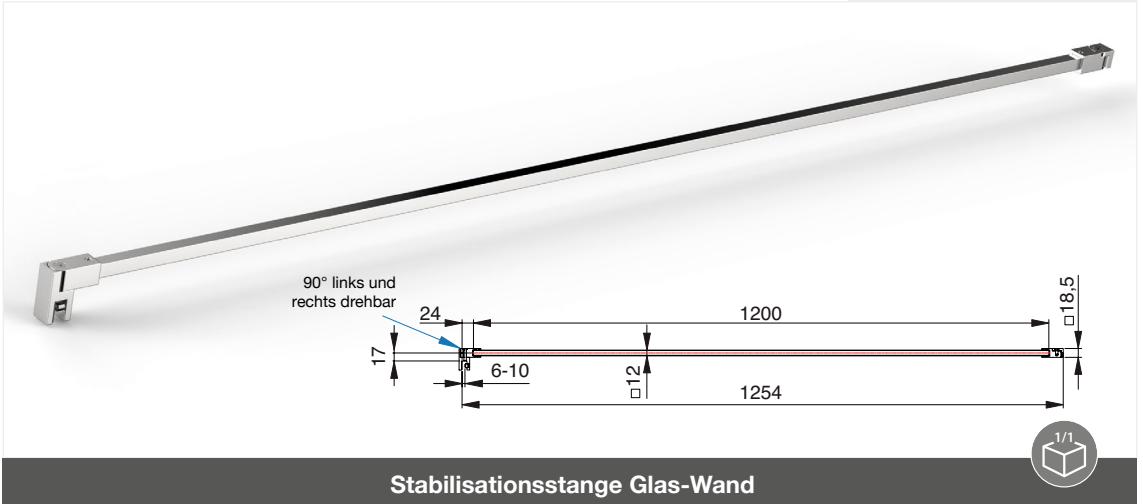

Rohrlänge 1200 mm, beliebig kürzbar

Art.-Nr.	Oberfläche	Glasdicke
8664MS7-1200	glanzverchromt	6-10 mm

DESIGNED
IN
GERMANY



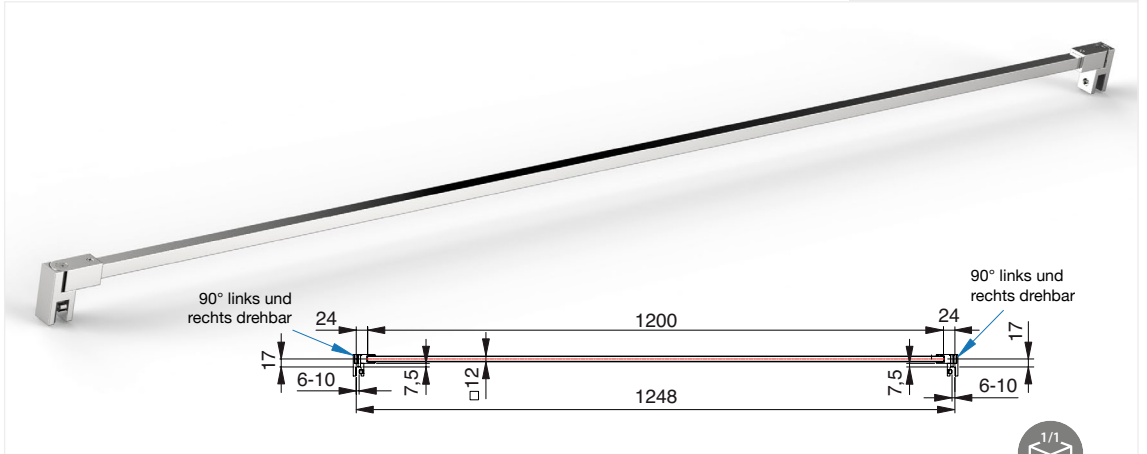

Stabilisationsstange Glas-Glas

Rohrlänge 1200 mm, beliebig kürzbar

Art.-Nr.	Oberfläche	Glasdicke
8666MS7-1200	glanzverchromt	6-10 mm

DESIGNED
IN
GERMANY



ZUBEHÖR
STABILISATIONSSTANGE ECKIG

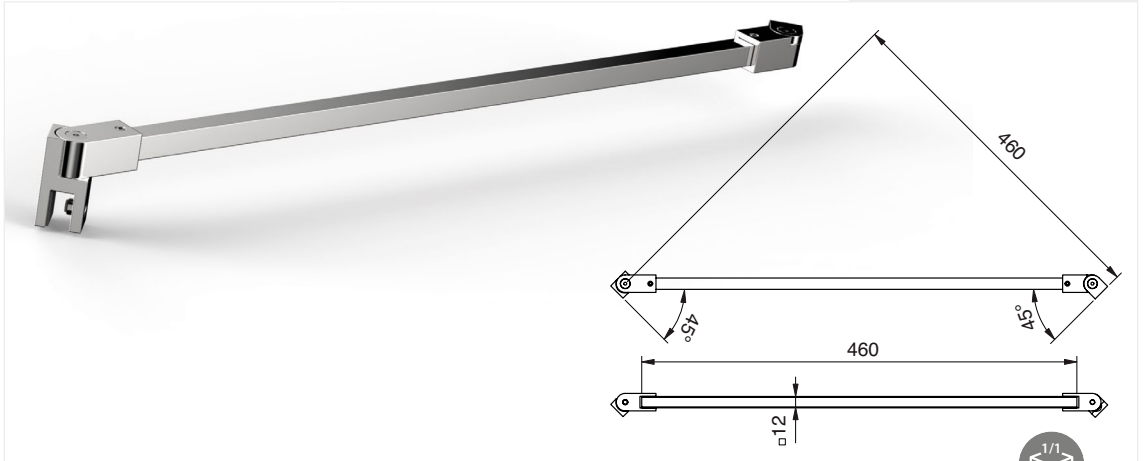

Stabilisationsstange Glas-Wand 45°

Rohrlänge 460 mm, beliebig kürzbar

Art.-Nr.	Oberfläche	Glasdicke
8665MS7-460	glanzverchromt	6-10 mm

DESIGNED
IN
GERMANY



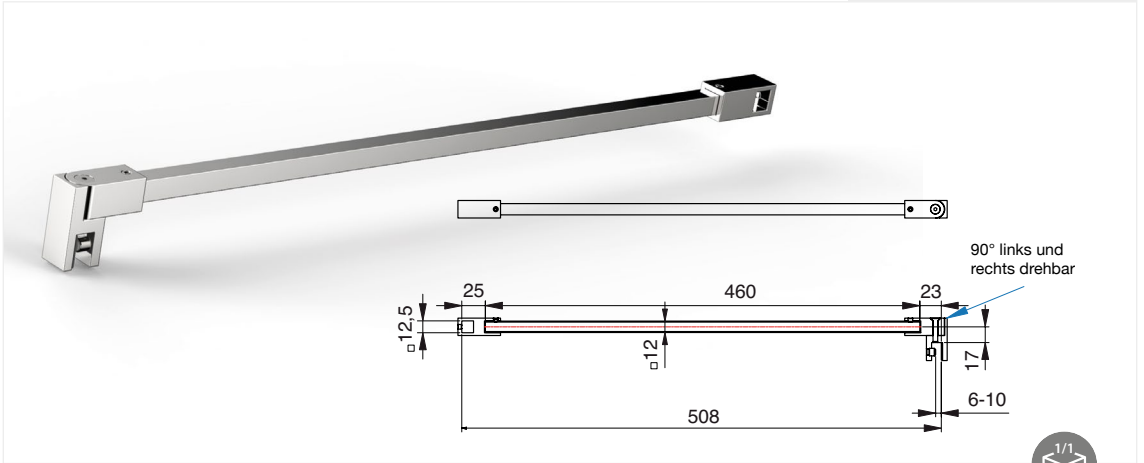
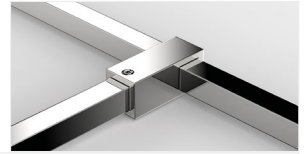

Stabilisationsstange Glas-T-Stück-Verbinder

Rohrlänge 460 mm, beliebig kürzbar

Art.-Nr.	Oberfläche	Glasdicke
8668MS7-460	glanzverchromt	6-10 mm

DESIGNED
IN
GERMANY



ZUBEHÖR DICHTPROFILE

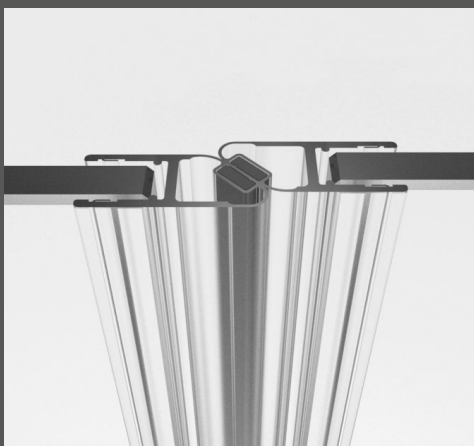
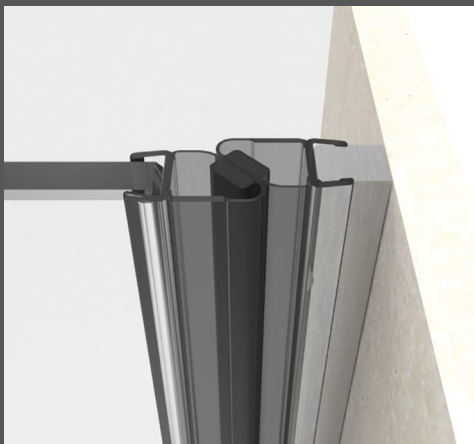
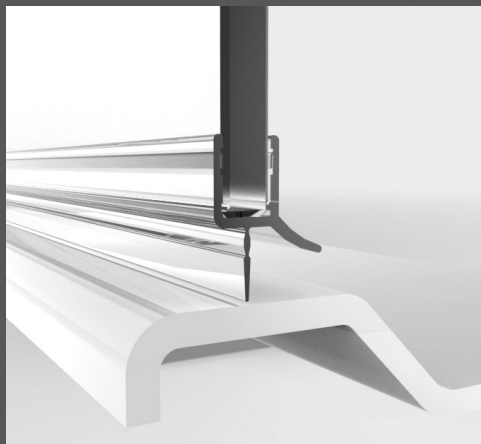

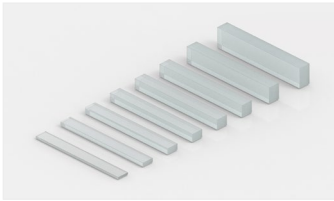
Montagehilfe - Distanz- und Trageklötz

Art.-Nr.	Stärke	VE
8890-1KU0-1	1 mm	25 Stück
8890-1KU0-2	2 mm	25 Stück
8890-1KU0-3	3 mm	25 Stück
8890-1KU0-4	4 mm	25 Stück

Art.-Nr.	Stärke	VE
8890-1KU0-5	5 mm	25 Stück
8890-1KU0-6	6 mm	25 Stück
8890-1KU0-8	8 mm	25 Stück
8890-1KU0-10	10 mm	25 Stück

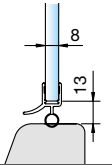
Dichtprofile für den unteren Wannenschluss

Art.-Nr. 8863KU0-8-2010

für 6 und 8 mm Glas

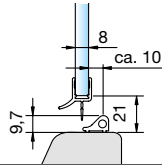

Art.-Nr. 8864KU0-8-2010

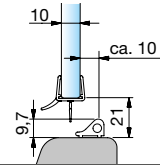
 für 6 und 8 mm Glas in Verbindung
mit dem Schwallenschutzprofil
(Art.-Nr. 8535E6EV5)

Art.-Nr. 8864KU0-12-2500

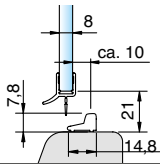
 für 10 und 12 mm Glas in Verbind-
ung mit dem Schwallenschutzprofil
(Art.-Nr. 8535E6EV5)

Art.-Nr. 8864KU0-8-2010

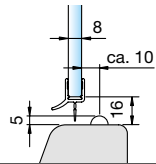
 für 6 und 8 mm Glas in Verbindung
mit dem Schwallenschutzprofil
(Art.-Nr. 8590E6EV5-2010)

Art.-Nr. 8864KU0-8-2010

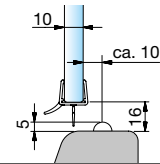
 für 6 und 8 mm Glas in Verbindung
mit dem Acrylhalbrundstab
(Art.-Nr. 8538KU5, Radius = 5 mm)

Art.-Nr. 8864KU0-12-2500

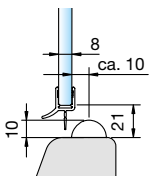
 für 10 und 12 mm Glas in Verbindung
mit dem Acrylhalbrundstab
(Art.-Nr. 8538KU5, Radius = 5 mm)

Art.-Nr. 8864KU0-8-2010

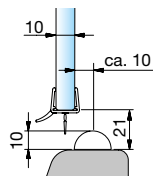
 für 6 und 8 mm Glas in Verbindung
mit dem Acrylhalbrundstab
(Art.-Nr. 8539KU5, Radius=10 mm)

Art.-Nr. 8864KU0-12-2500

 für 10 und 12 mm Glas in Verbindung
mit dem Acrylhalbrundstab (Art.-Nr. 8539KU5, Radius=10 mm)

 *Art.-Nr.-Material/Oberfläche:
KU0 = Kunststoff naturfarbig-opak

 Achtung: Die hier dargestellten Abzugsmaße gelten
nur für 8 bzw. 10 mm Glas! Abzugsmaß bei 6 bzw.
12 mm auf Anfrage!

Dichtprofile für Glas-Glas 90°

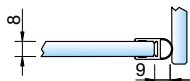

Art.-Nr. 8861KU0-8-2010

Art.-Nr. 8861KU0-8-2500

für 6 und 8 mm Glas für ein ein- und beidseitig zu öffnendes Duschtürband

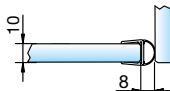

Art.-Nr. 8861KU0-12-2500

Art.-Nr. 8861KU0-12-3000

für 10 und 12 mm Glas für ein ein- und beidseitig zu öffnendes Duschtürband

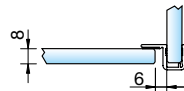

Art.-Nr. 8855KU0-8-2010

Art.-Nr. 8855KU0-8-2500

für 6 und 8 mm Glas für ein einseitig nach außen hin öffnendes Duschtürband

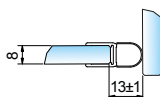

Art.-Nr. 8842KU0-8-2010

für 8 mm Glas für ein ein- und beidseitig zu öffnendes Duschtürband

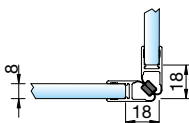

Art.-Nr. 8851KU0-8-2010

Art.-Nr. 8851KU0-8-2500

für 6 und 8 mm Glas für ein einseitig nach außen hin öffnendes Duschtürband

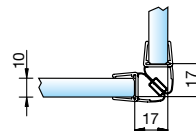

Art.-Nr. 8851KU0-12-2500

für 10 und 12 mm Glas für ein einseitig nach außen hin öffnendes Duschtürband

Dichtprofile für Glas-Glas 135°

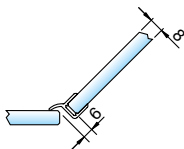

Art.-Nr. 8860KU0-8-2010

Art.-Nr. 8860KU0-8-2500

für 6 und 8 mm Glas für ein einseitig öffnendes Duschtürband

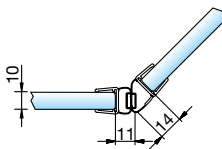

Art.-Nr. 8875KU0-12-2500

für 10 und 12 mm Glas für ein ein- und beidseitig zu öffnendes Duschtürband

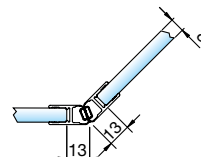

Art.-Nr. 8853KU0-8-2010

Art.-Nr. 8853KU0-8-2500

für 6 und 8 mm Glas für ein einseitig nach außen hin öffnendes Duschtürband

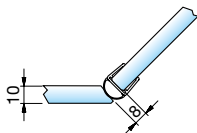

Art.-Nr. 8861KU0-12-2500

Art.-Nr. 8861KU0-12-3000

für 10 und 12 mm Glas für ein beidseitig zu öffnendes Duschtürband

Dichtprofile für Glas-Glas 180°

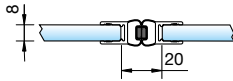

Art.-Nr. 8850KU0-8-2010

Art.-Nr. 8850KU0-8-2500

für 6 und 8 mm Glas für ein beidseitig öffnendes Duschtürband

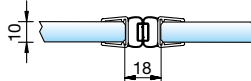

Art.-Nr. 8850KU0-12-2500

für 10 und 12 mm Glas für ein beidseitig öffnendes Duschtürband

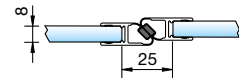

Art.-Nr. 8852KU0-8-2010

Art.-Nr. 8852KU0-8-2500

für 6 und 8 mm Glas für ein einseitig öffnendes Duschtürband

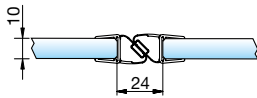

Art.-Nr. 8852KU0-12-2500

für 10 und 12 mm Glas für ein einseitig öffnendes Duschtürband

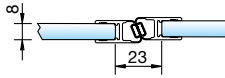

Art.-Nr. 8854KU0-8-2010

Art.-Nr. 8854KU0-8-2500

für 6 und 8 mm Glas für ein einseitig öffnendes Duschtürband

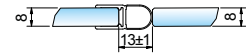

Art.-Nr. 8842KU0-8-2010

für 8 mm Glas für ein ein- und beidseitig zu öffnendes Duschtürband

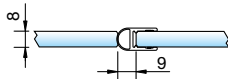

Art.-Nr. 8861KU0-8-2010

Art.-Nr. 8861KU0-8-2500

für 6 und 8 mm Glas für ein beidseitig öffnendes Duschtürband

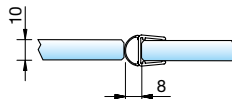

Art.-Nr. 8861KU0-12-2500

Art.-Nr. 8861KU0-12-3000

für 10 und 12 mm Glas für ein beidseitig öffnendes Duschtürband



Art.-Nr. 8865KU0-8-2010

Art.-Nr. 8865KU0-8-2500

für 8 mm Glas für ein einseitig öffnendes Duschtürband

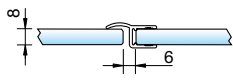

Art.-Nr. 8857KU0-8-2010

Art.-Nr. 8857KU0-8-2500

für 6 und 8 mm Glas für ein einseitig öffnendes Duschtürband

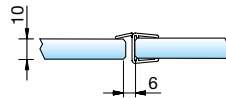

Art.-Nr. 8857KU0-12-2500

für 10 und 12 mm Glas für ein einseitig öffnendes Duschtürband

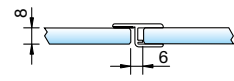

Art.-Nr. 8856KU0-8-2010

Art.-Nr. 8856KU0-8-2500

für 6 und 8 mm Glas für ein einseitig öffnendes Duschtürband

*Art.-Nr.-Material/Oberfläche:
KU0 = Kunststoff naturfarbig-opak

Achtung: Die hier dargestellten Abzugsmaße gelten nur für 8 bzw. 10 mm Glas! Abzugsmaß bei 6 bzw. 12 mm auf Anfrage!

Dichtprofile für den seitlichen Wandanschluss 90° (Beschlagseite)

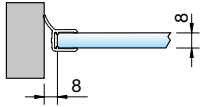

Art.-Nr. 8862KU0-8-2010

Art.-Nr. 8862KU0-8-2500

für 6 und 8 mm Glas als Wanddichtung für ein einseitig nach außen öffnendes Duschtürband

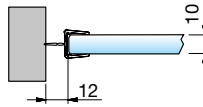

Art.-Nr. 8876KU0-12-2500

für 10 und 12 mm Glas als Wanddichtung für ein beidseitig öffnendes Duschtürband

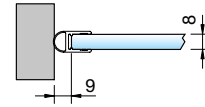

Art.-Nr. 8861KU0-8-2010

Art.-Nr. 8861KU0-8-2500

für 6 und 8 mm Glas als Wanddichtung für ein beidseitig öffnendes Duschtürband

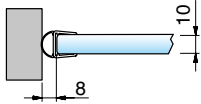

Art.-Nr. 8861KU0-12-2500

Art.-Nr. 8861KU0-12-3000

für 10 und 12 mm Glas als Wanddichtung für ein beidseitig öffnendes Duschtürband

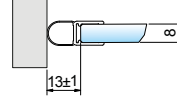

Art.-Nr. 8842KU0-8-2010

für 8 mm Glas für ein ein- und beidseitig zu öffnendes Duschtürband

Dichtprofile für den seitlichen Wandanschluss 90° (Griffseite)

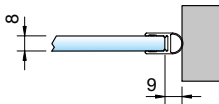

Art.-Nr. 8861KU0-8-2010

Art.-Nr. 8861KU0-8-2500

für 6 und 8 mm Glas als Wanddichtung für ein beidseitig öffnendes Duschtürband

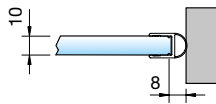

Art.-Nr. 8861KU0-12-2500

Art.-Nr. 8861KU0-12-3000

für 10 und 12 mm Glas als Wanddichtung für ein beidseitig öffnendes Duschtürband

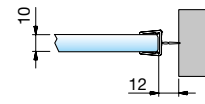

Art.-Nr. 8876KU0-12-2500

für 10 und 12 mm Glas als Wanddichtung für ein beidseitig öffnendes Duschtürband

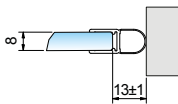

Art.-Nr. 8842KU0-8-2500

für 8 mm Glas für ein ein- und beidseitig zu öffnendes Duschtürband

Schwallschutzprofile

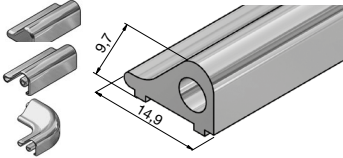

Art.-Nr. SET-8535E6EV5-1860

Art.-Nr. SET-8535E0/14-1860

Schwallschutzprofil in einer Länge von 1860 mm, inkl. 1x Endstück links, 1x Endstück rechts, 1x Schwallschutz-Eckverbindung 90°

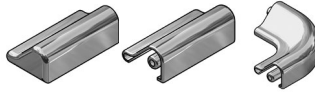

Art.-Nr. SET-8536E6/EV5-90

Art.-Nr. SET-8536E0/14-90

1x Endstück links, 1x Endstück rechts, 1x Schwallschutz-Eckverbindung 90°

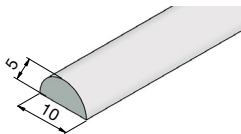

Art.-Nr. 8538KU5

Schwallschutzprofil (Acrylstab) in einer Länge von 2000 mm

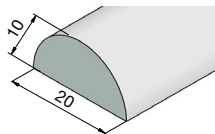

Art.-Nr. 8539KU5

Schwallschutzprofil (Acrylstab) in einer Länge von 2000 mm

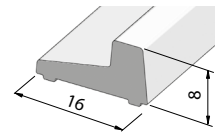

Art.-Nr. 8585E6EV5-2010

Schwallschutzprofil in eckiger Version, Länge 2010 mm

Trägerprofil für Türanschlag

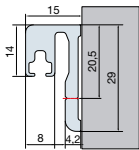

Art.-Nr. 8880E6/EV1-2010

Art.-Nr. 8880E6/EV5-2010

Länge = 2010 mm

Art.-Nr. 8880E6/EV1-2500

Art.-Nr. 8880E6/EV5-2500

Länge = 2500 mm

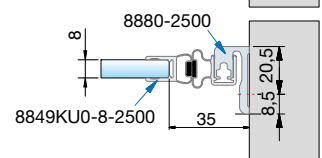
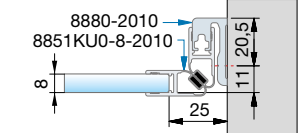
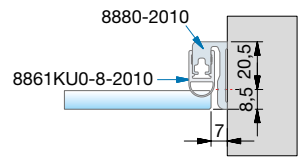
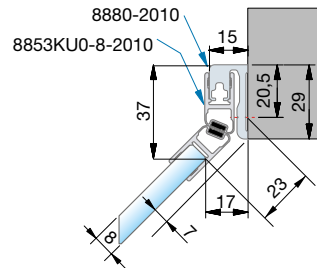
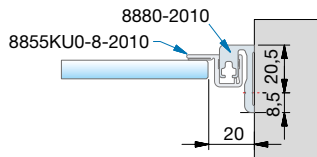

*Art.-Nr.-Material/Oberfläche:

E6/EV1 = Alu-Optik (silberfarbig eloxiert)

E6/EV5 = Aluminium spezialgebeizt glanzeloxiert

E0/14 = Aluminium weiß pulverbeschichtet RAL 9016

KU5 = Kunststoff glasklar

KU0 = Kunststoff naturfarbig-opak

Achtung: Die hier dargestellten Abzugsmaße gelten nur für 8 bzw. 10 mm Glas! Abzugsmaß bei 6 bzw. 12 mm auf Anfrage!

ZUBEHÖR SCHWARZE DICHTPROFILE

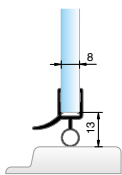

Art.-Nr. 8863KU35-8-2500

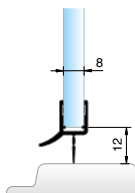

Art.-Nr. 8864KU35-8-2500

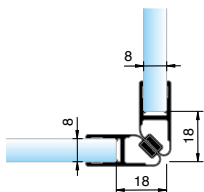

Art.-Nr. 8851KU35-8-2500

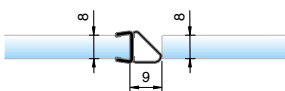

Art.-Nr. 8845KU35-8K-2500

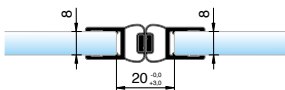
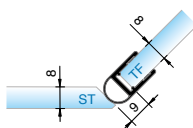
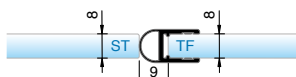

Art.-Nr. 8850KU35-8-2500

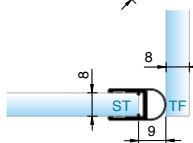

Art.-Nr. 8861KU35-8-2500

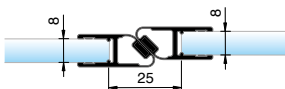

Art.-Nr. 8852KU35-8-2500

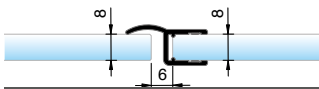

Art.-Nr. 8857KU35-8-2500

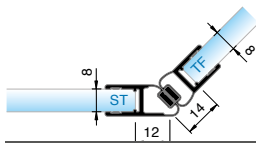

Art.-Nr. 8875KU35-8-2500



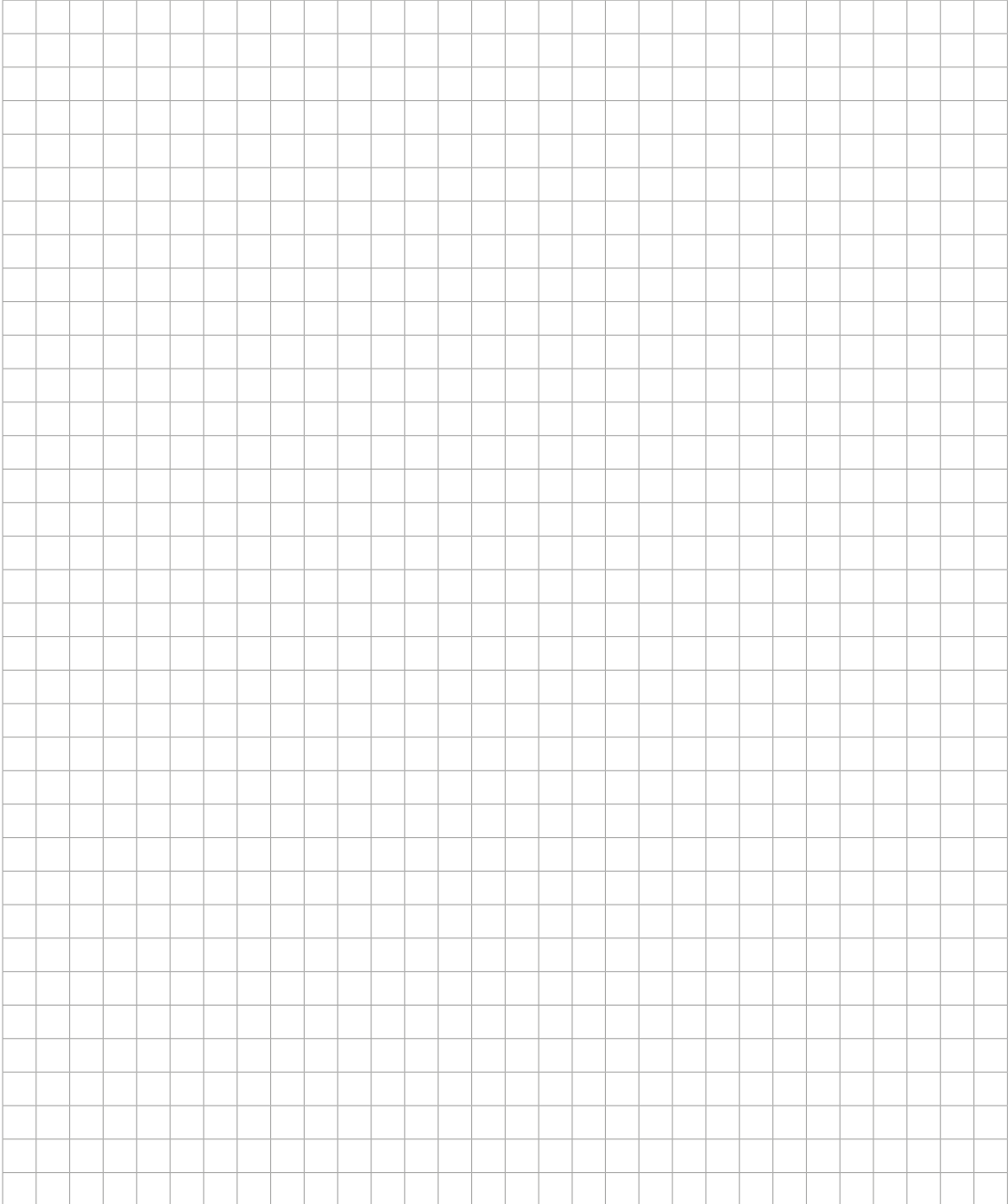

ZUBEHÖR
U-PROFILE



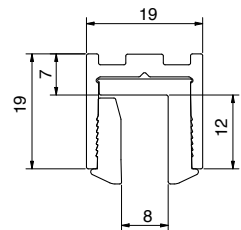
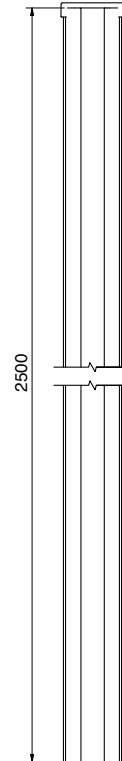
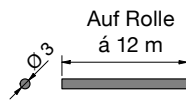
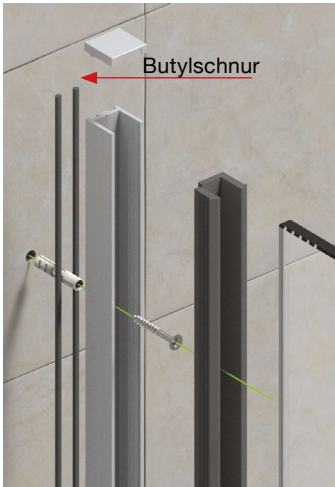

8830-2Butyl-12M – optional bestellbar
 Butylschnur \varnothing 3 mm, Länge 12 m,
 als Abdichtung zur Wand ohne anschließende Silikonfuge
 (nicht lastabtragend)

U-Profil



1 Nut 15 x 15 mm, maximale Höhe 2500 mm, beliebig kürzbar

Art.-Nr.	Oberfläche	Glasdicke	Länge
8830E6EV5-2500	Aluminium glanzeloxiert	8 mm mit Verglasungsprofilen oder Silikonfuge 10 mm mit Silikonfuge 12 mm mit Silikonfuge	2500 mm
8830E3/50-2500	glanzverchromt		
8830E123-2500	Edelstahloptik		
8830E6C35-2500	schwarz eloxiert		

ZUBEHÖR U-PROFILE

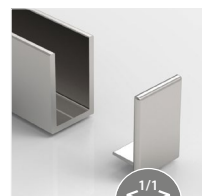
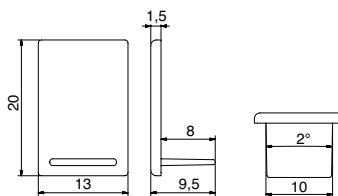
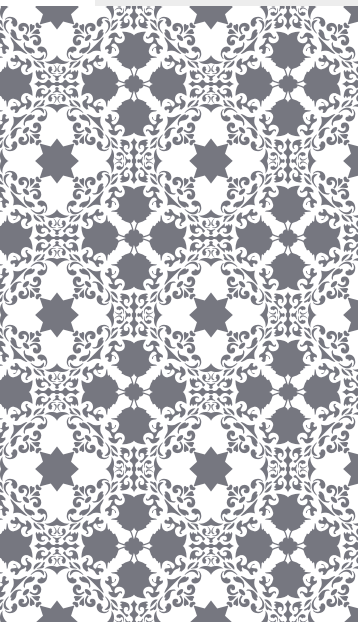

Endkappen für Profil 8841

geschlossen

Art.-Nr.	Oberfläche
8841-2KU6U7	naturfarbig eloxiert (glänzend)
8841-2KU12	gold matt eloxiert
8841-2KU3	schwarz eloxiert

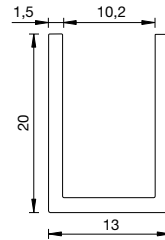
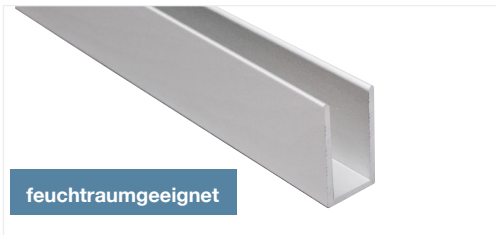
U-Profil 20x13x2010x1,5 mm

Art.-Nr.	Oberfläche	Plattendicke
8841E6EV5-2010	Aluminium glanzeloxiert	6-10 mm

U-Profil 20x13x2500x1,5 mm

Art.-Nr.	Oberfläche	Plattendicke
8841E6EV5-2500	Aluminium glanzeloxiert	6-10 mm

U-Profil 20x13x5000x1,5 mm

Art.-Nr.	Oberfläche	Plattendicke
8841E6EV1-5M	Aluminium naturfarbig eloxiert	6-10 mm
8841E123-5M	Aluminium eloxiert edelstahlfinish	6-10 mm
8841E3/50-5M	Aluminium glanzverchromt	6-10 mm
8841E3EV3-5M	Aluminium gold eloxiert	6-10 mm
8841E6C35-5M	Aluminium schwarz eloxiert	6-10 mm

doppelseitiges Klebeband, transparent, Stärke 2 mm

Art.-Nr.	Breite des Klebestreifens	
7269KL-9-5M	9mm	5m Rolle
7269KL-11-5M	11mm	5m Rolle
7269KL-15-5M	15mm	5m Rolle
7269KL-19-5M	19mm	5m Rolle
7269KL-23-5M	23mm	5m Rolle

Wichtiger Hinweis:

Nur als Abdichtungs- oder Montagehilfe. Trotz der hohen Klebkraft ersetzen diese keine mechanische Befestigung (Schrauben).



feuchtraumgeeignet

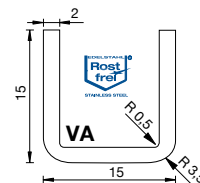
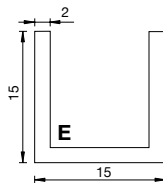

U-Profil 15x15x2500x2 mm



Art.-Nr.	Oberfläche	Plattendicke
5015VA1-2500	Edelstahl poliert	≤ 10 mm
5015VA2-2500	Edelstahl matt gebürstet	≤ 10 mm
5015E6EV5-2.5M	Aluminium glanzeloxiert	≤ 10 mm
5015E6C35-2.5M	Aluminium schwarz matt	≤ 10 mm

U-Profil 15x15x5000x2 mm

Art.-Nr.	Oberfläche	Plattendicke
5015VA1-5M	Edelstahl poliert	≤ 10 mm
5015VA2-5M	Edelstahl matt gebürstet	≤ 10 mm
5015E6EV1-5M	Aluminium naturfarbig eloxiert	≤ 10 mm
5015E1/22-5M	Aluminium eloxiert edelstahlfinish	≤ 10 mm
5015E1/23-5M	Aluminium eloxiert Edelstahloptik	≤ 10 mm
5015E3/50-5M	Aluminium glanzverchromt	≤ 10 mm
5015E0/14-5M	Aluminium pulverbeschichtet RAL9016	≤ 10 mm
5015E6C35-5M	Aluminium schwarz eloxiert	≤ 10 mm

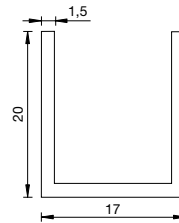
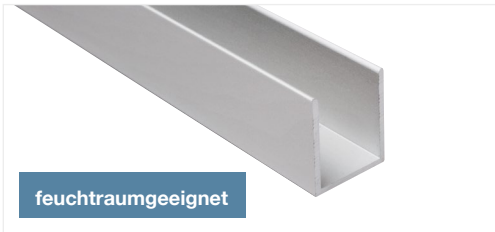
U-Profil 20x17x5000x1,5 mm

Art.-Nr.	Oberfläche	Plattendicke
5017E6EV5-5M	Aluminium glanzeloxiert	≤ 14 mm
5017E6EV1-5M	Aluminium naturfarbig eloxiert	≤ 14 mm
5017E1/22-5M	Aluminium eloxiert edelstahlfinish	≤ 14 mm
5017E1/23-5M	Aluminium eloxiert Edelstahloptik	≤ 14 mm
5017E3/50-5M	Aluminium glanzverchromt	≤ 14 mm
5017E0/14-5M	Aluminium pulverbeschichtet RAL9016	≤ 14 mm

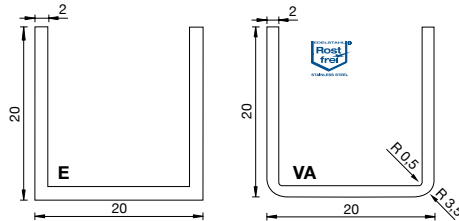
U-Profil 20x20x2500x2 mm

Art.-Nr.	Oberfläche	Plattendicke
5020VA1-2500	Edelstahl poliert	≤ 16 mm
5020VA2-2500	Edelstahl matt gebürstet	≤ 16 mm

U-Profil 20x20x5000x2 mm

Art.-Nr.	Oberfläche	Plattendicke
5020VA1-5M	Edelstahl poliert	≤ 16 mm
5020VA2-5M	Edelstahl matt gebürstet	≤ 16 mm
5020E6EV1-5M	Aluminium naturfarbig eloxiert	≤ 16 mm
5020E1/22-5M	Aluminium eloxiert edelstahlfinish	≤ 16 mm
5020E1/23-5M	Aluminium eloxiert Edelstahloptik	≤ 16 mm
5020E3/50-5M	Aluminium glanzverchromt	≤ 16 mm
5020E0/14-5M	Aluminium pulverbeschichtet RAL9016	≤ 16 mm
5020E6C35-5M	Aluminium schwarz eloxiert	≤ 10 mm

Achtung: Bei Profilen mit der Oberfläche E3/50 müssen in Feuchträumen die Schnittkanten sehr gut versiegelt werden!

ZUBEHÖR KLEMPROFIL



MADE
IN
GERMANY

Einzelne Klemmbacken auf gesamter Länge frei positionierbar
2010 mm = 5 Klemmbacken, 2500 mm = 6 Klemmbacken

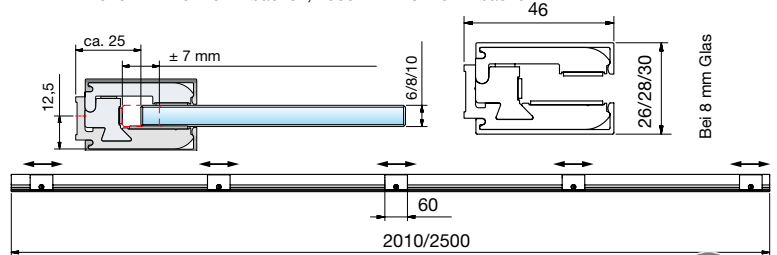

Klemmprofil



Art.-Nr.	Oberfläche	Glasdicke
8884E1/23-2010-8	Aluminium geschliffen silberfarbig eloxiert (Edelstahloptik)	6/8/10 mm
8884E1/23-2500-8		
8884E6EV1-2010-8	Aluminium spezialgebeizt naturfarbig eloxiert	6/8/10 mm
8884E6EV1-2500-8		
8884E6EV1-5000-8		
8884E6EV5-2010-8	Aluminium spezialgebeizt glanzeloxiert	6/8/10 mm
8884E6EV5-2500-8		

Bitte folgende Sets kostenlos mitbestellen:
für 6 mm Glasdicke

8884-10ZN0-5-6 für 2010 mm/ 8884-10ZN0-6-6 für 2500mm/ 8884-10ZN0-6-6 für 5000 mm – 2x pro Klemmprofil

für 10 mm Glasdicke

8884-10ZN0-5-10 für 2010 mm/ 8884-10ZN0-6-10 für 2500 mm/ 8884-10ZN0-6-10 für 5000 mm – 2x pro Klemmprofil

Endkappen sind nicht im Set enthalten!

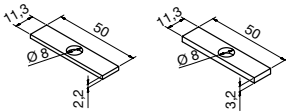

Zwischenanlage zu 8884

Art.-Nr.	Oberfläche
8885HZ	Hartzellmaterial

Zwischenlagen für 8884 zum Ausgleich von Unebenheiten in der Wand, 5 pro Stärke im Set enthalten. Durch Kombination und/ oder Verdopplung können Unebenheiten ab 2 mm in 1 mm Schritten ausgeglichen werden.

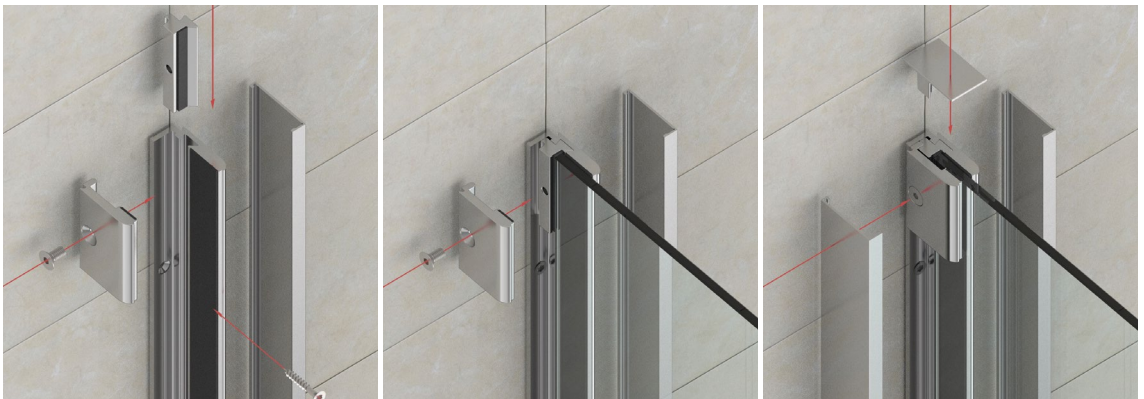

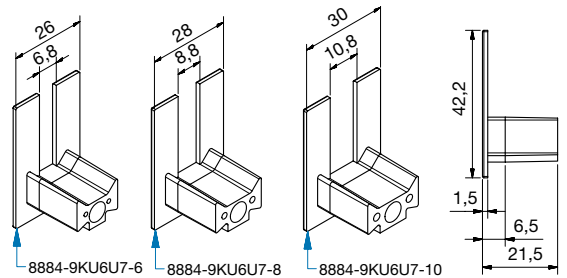
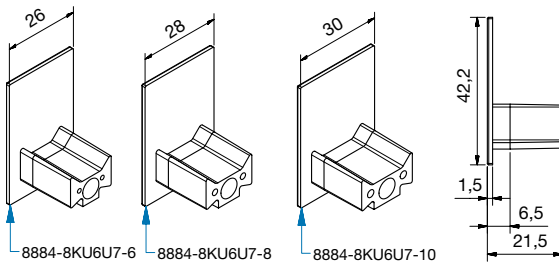
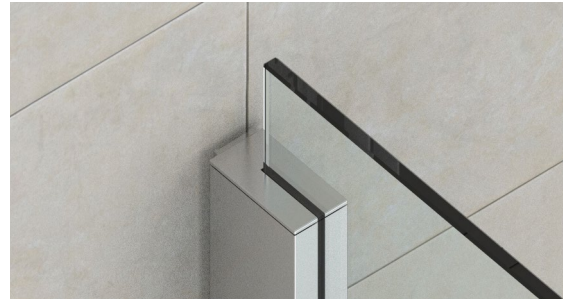
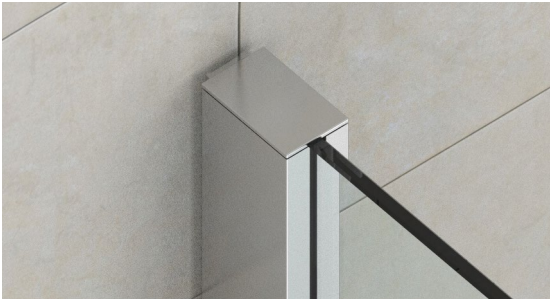

Endkappen für Klemmprofil 8884



geschlossen

Art.-Nr.	Oberfläche	Glasdicke
8884-8KU6U7-6	*	6 mm
8884-8KU22-6	**	6 mm
8884-8KU6U7-8	*	8 mm
8884-8KU6U7-10	*	10 mm
8884-8KU22-10	**	10 mm

* KU6U7 ist für E6/EV1 und E6/EV5

** KU22 ist für E1/23

Endkappen für Klemmprofil 8884



ausgeklinkt

Art.-Nr.	Oberfläche	Glasdicke
8884-9KU6U7-6	*	6 mm
8884-9KU22-6	**	6 mm
8884-9KU227-8	*	8 mm
8884-9KU22-8	**	8 mm
8884-9KU6U7-10	*	10 mm
8884-9KU22-10	**	10 mm

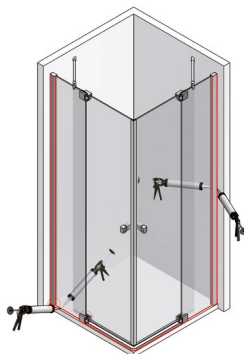

Hinweis:
Der Klemmrahmen sowie
das Glas der Dusche
muss versiegelt werden.

ZUBEHÖR
WALK-IN – SYSTEMPROFIL



VERSCHIEDENE LÖSUNGEN – SCHNELL UMGESETZT



- Länge: 2800 mm
- Rohr in der Länge kürzbar
- Rohr 32 x 32 mm
- besonders geeignet für individuelle Lösungen
- maximaler Gestaltungsspielraum
- einfache Montage
- Ausgleich von schiefen Wänden bis ca. 6 mm
- Verbauung mit LEDs möglich
- unsichtbare Verschraubung
- keine zusätzlichen Stabilisierungsstangen erforderlich



Durch das geteilte Gummiprofil lässt sich die Glasscheibe problemlos einsetzen.



Anschraubvariante

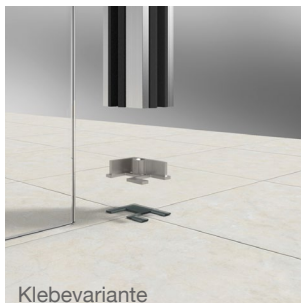

Klebevariante



Wir bieten verschiedene Möglichkeiten beim Anschluss am Boden.
Beide Varianten müssen mit Silikon versiegelt werden.



1 Variante an der Wand

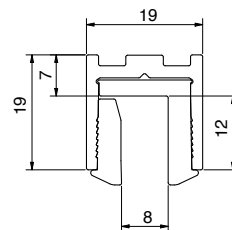
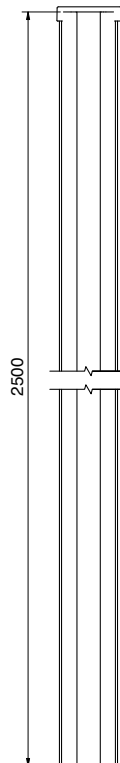
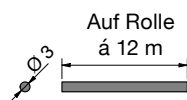
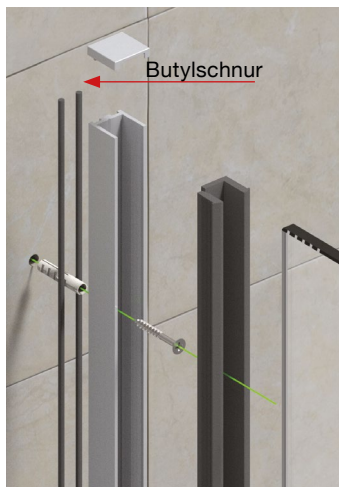

8830-2Butyl-12M – optional bestellbar
Butylschnur Ø 3 mm, Länge 12 m,
als Abdichtung zur Wand ohne anschließende Silikonfuge
(nicht lastabtragend)

U-Profil



1 Nut 15 x 15 mm, maximale Höhe 2500 mm, beliebig kürzbar

Art.-Nr.	Oberfläche	Glasdicke	Länge
8830E6EV5-2500	Aluminium glanzeloxiert	8 mm mit Verglasungsprofilen oder Silikonfuge 10 mm mit Silikonfuge 12 mm mit Silikonfuge	2500 mm
8830E3/50-2500	glanzverchromt		
8830E123-2500	Edelstahloptik		
8830E6C35-2500	schwarz eloxiert		

2 Variante mit einem Glas – Befestigung an der Decke

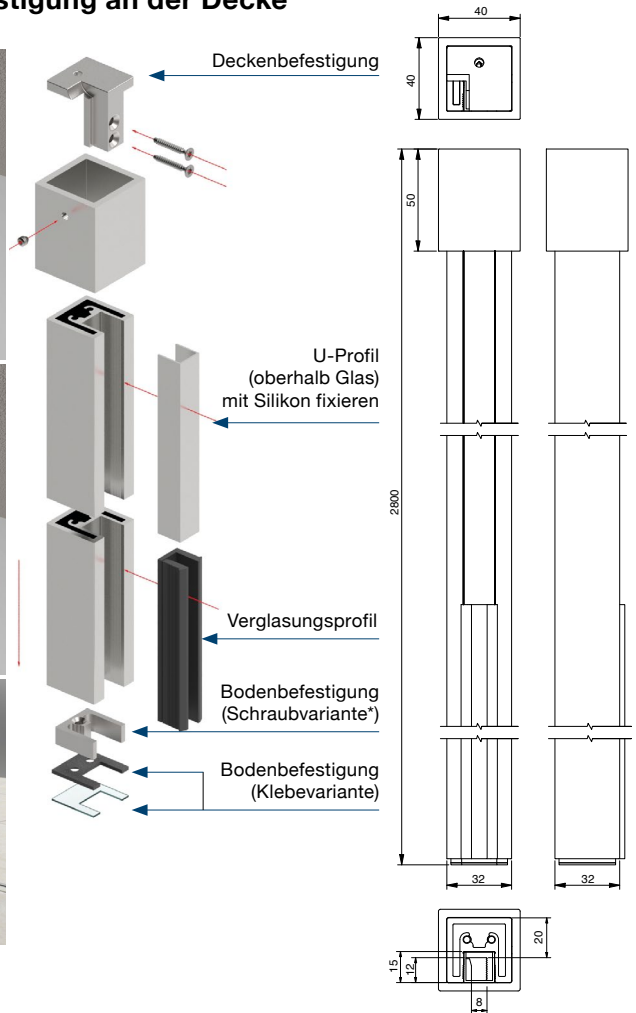
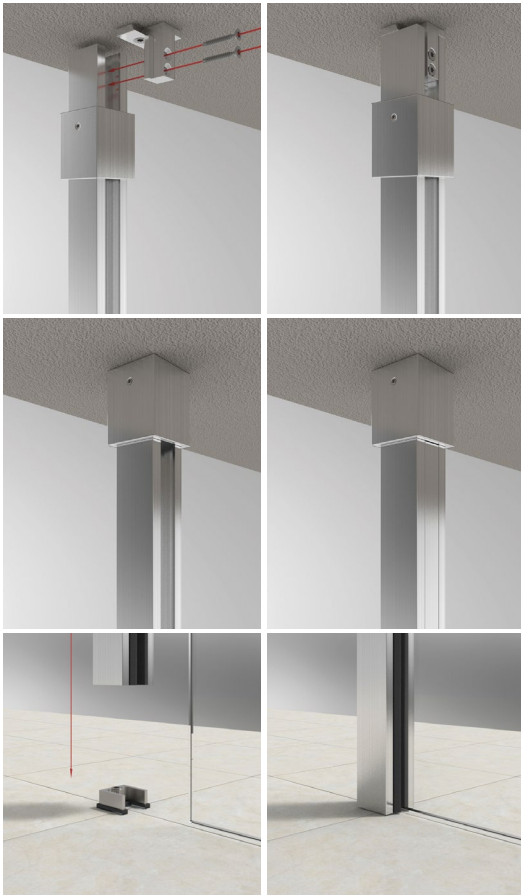

Trennwandstütze Boden-Decke



1 Nut 15 x 15 mm, U-Profil als Füllung oberhalb der Glaskante zur Decke hin

Art.-Nr.	Oberfläche	Glasdicke	Länge
8888E6EV5-BD	Aluminium glanzeloxiert	8 mm mit Verglasungsprofilen oder Silikonfuge 10 mm mit Silikonfuge 12 mm mit Silikonfuge	2500 mm
8888E3/50-BD	glanzverchromt		
8888E123-BD	Edelstahloptik		
8888E6C35-BD	schwarz eloxiert		



3 Variante mit zwei Gläsern – Befestigung an der Decke

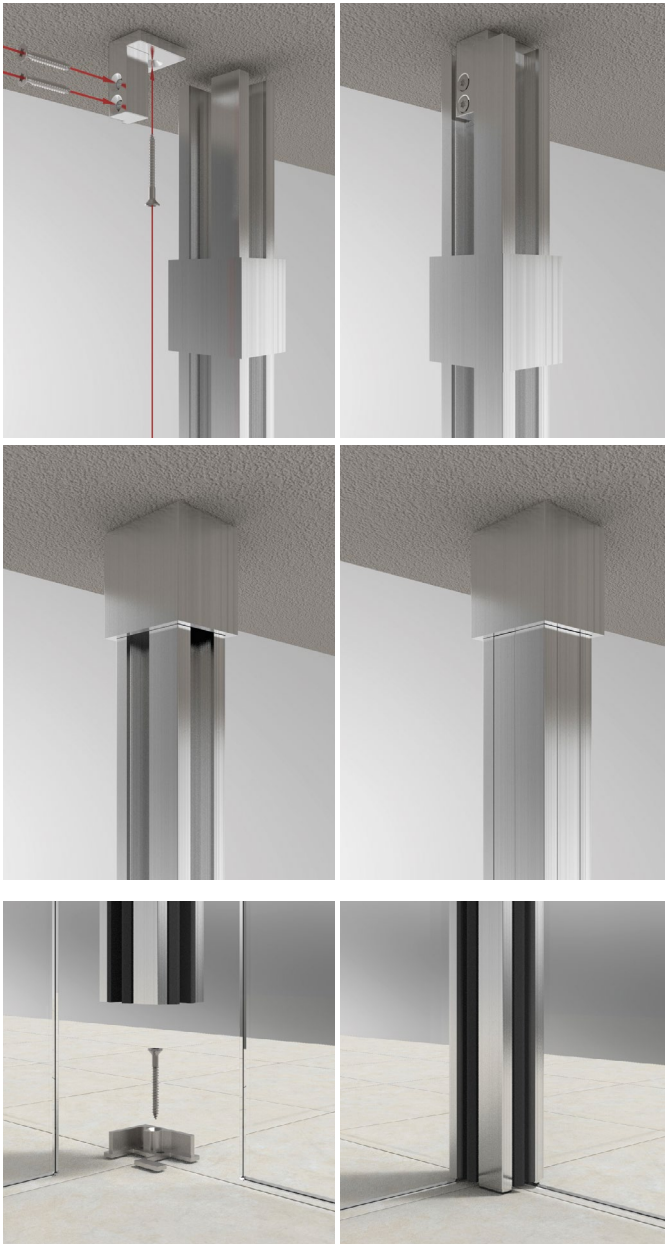

3 Variante mit zwei Gläsern – Befestigung an der Decke

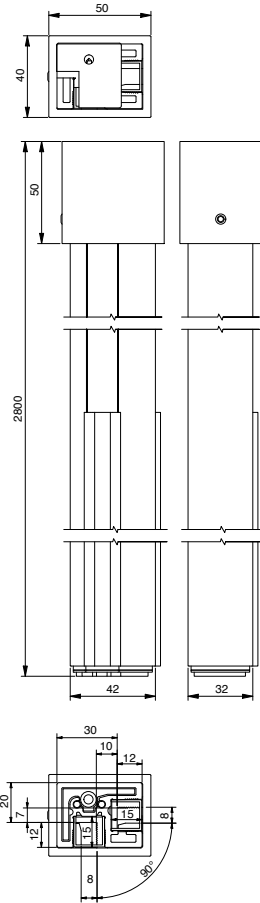
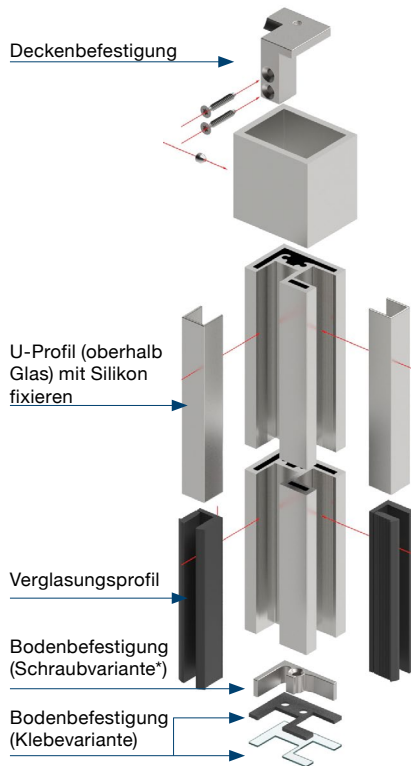

Trennwandstütze Boden-Decke 90°



2 Nuten 15 x 15 mm, U-Profil als Füllung oberhalb der Glaskante zur Decke hin

Art.-Nr.	Oberfläche	Glasdicke	Länge
8888E6EV5-BD2N	Aluminium glanzeloxiert	8 mm mit Verglasungsprofilen oder Silikonfuge 10 mm mit Silikonfuge 12 mm mit Silikonfuge	2500 mm
8888E3/50-BD2N	glanzverchromt		
8888E123-BD2N	Edelstahloptik		
8888E6C35-BD2N	schwarz eloxiert		

4 Variante mit einem Glas – Befestigung an der Wand

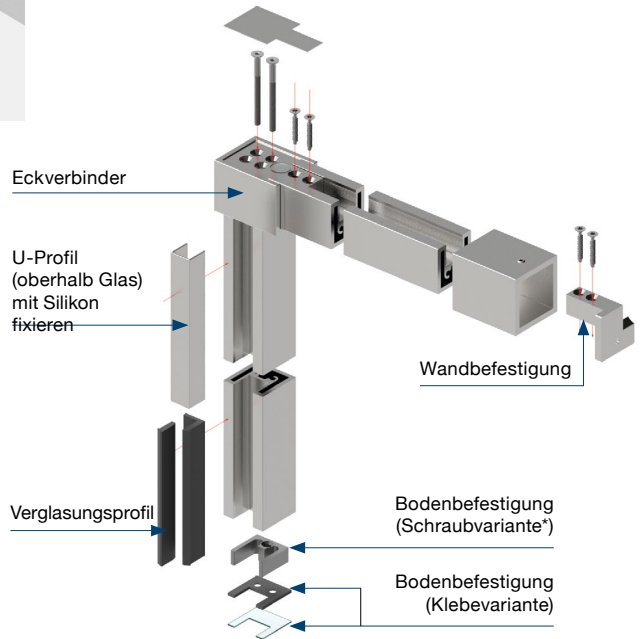
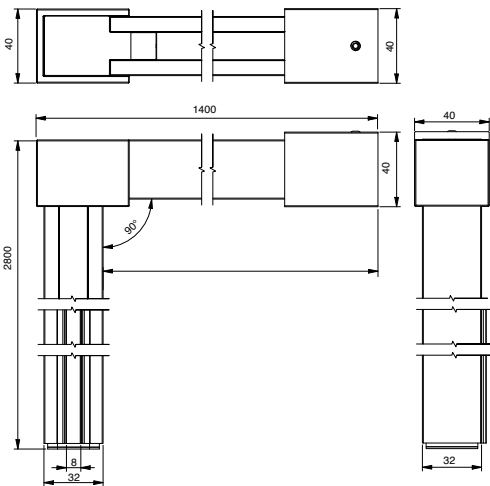
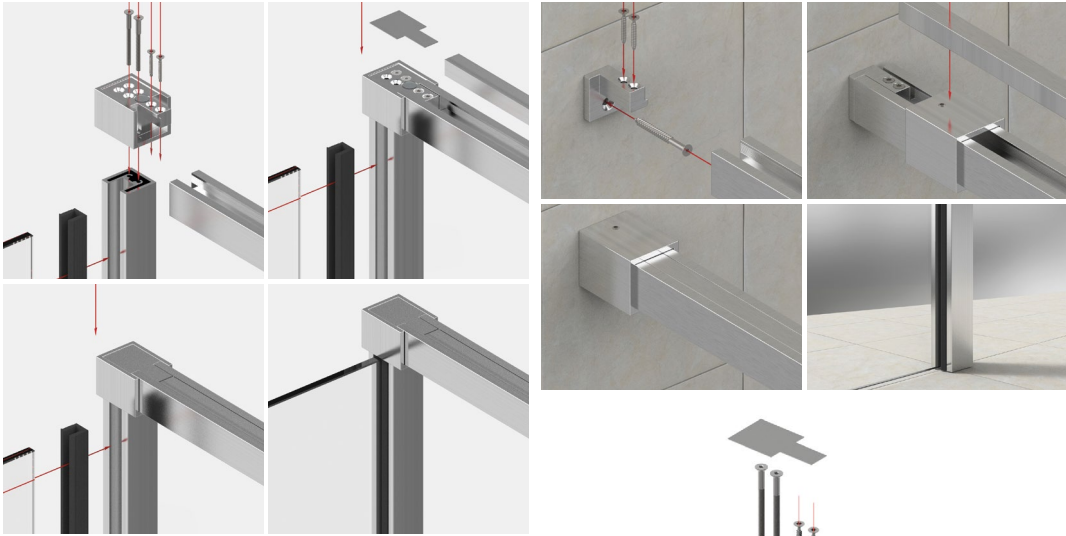

* Damit die Wassersperre im Bad durch das nachträgliche Anbohren der unteren Befestigungsplatte nicht verletzt wird, sollte der Fliesenleger den Befestigungsadapter vorher in den Bodenaufbau einarbeiten und entsprechend der Beanspruchungskategorie die richtige Feuchtraumabdichtung nach den anerkannten Richtlinien ausführen.

4 Variante mit einem Glas – Befestigung an der Wand

Trennwandstütze Boden-Wand



1 Nut 15 x 15 mm, U-Profil als Füllung oberhalb Glaskante zur Wand hin

Art.-Nr.	Oberfläche	Glasdicke	Länge
8888E6EV5-BW	Aluminium glanzeloxiert	8 mm mit Verglasungsprofilen oder Silikonfuge 10 mm mit Silikonfuge 12 mm mit Silikonfuge	2800 mm + 1400 mm
8888E3/50-BW	glanzverchromt		
8888E123-BW	Edelstahloptik		
8888E6C35-BW	schwarz eloxiert		

5

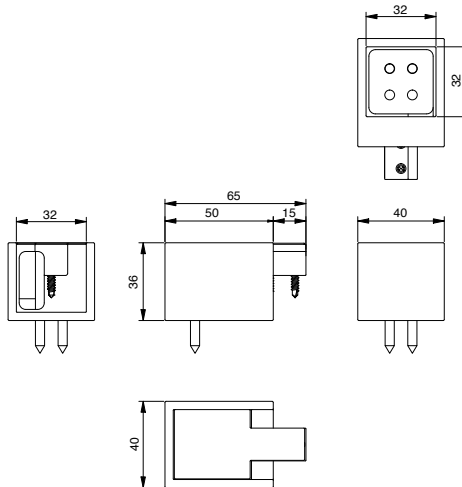

Eckverbinder Trennwandstütze



links und rechts verwendbar, nur in Verbindung 8888E0-BW Trennwandstütze

Art.-Nr.	Oberfläche	Glasdicke	
8888E3/50-EV	glanzverchromt	8 mm mit Verglasungsprofilen oder Silikonfuge 10 mm mit Silikonfuge 12 mm mit Silikonfuge	
8888E123-EV	Edelstahloptik		
8888E6C35-EV	schwarz eloxiert		



GLASSYSTEME

Ideen. Leidenschaft. Perfektion.

SWS Glassysteme GmbH
Boehringer Straße 2a
D-68307 Mannheim
info@sws-glassysteme.de
www.sws-glassysteme.de

Niederlassung:
Eisenstraße 2
51545 Waldbröl
Telefon: (+49) 02291-7905-0
Telefax: (+49) 02291-7905-10